

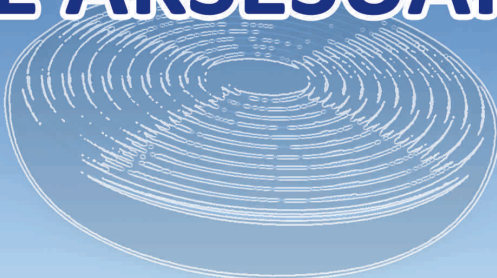

# YÜKSELSAN

**KAYAR ÇATI SİSTEMLERİ  
VE AKSESUARLARI**

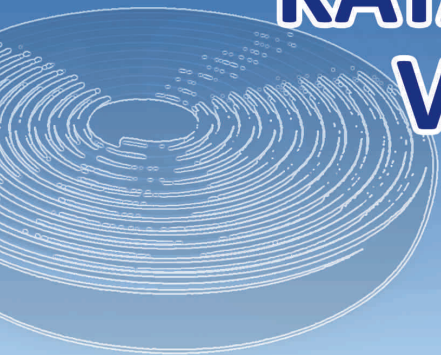



**YÜKSELSAN**  
KAYAR ÇATI SİSTEMLERİ ve AKSESUARLARI

## Kayar Çatı Sistemi

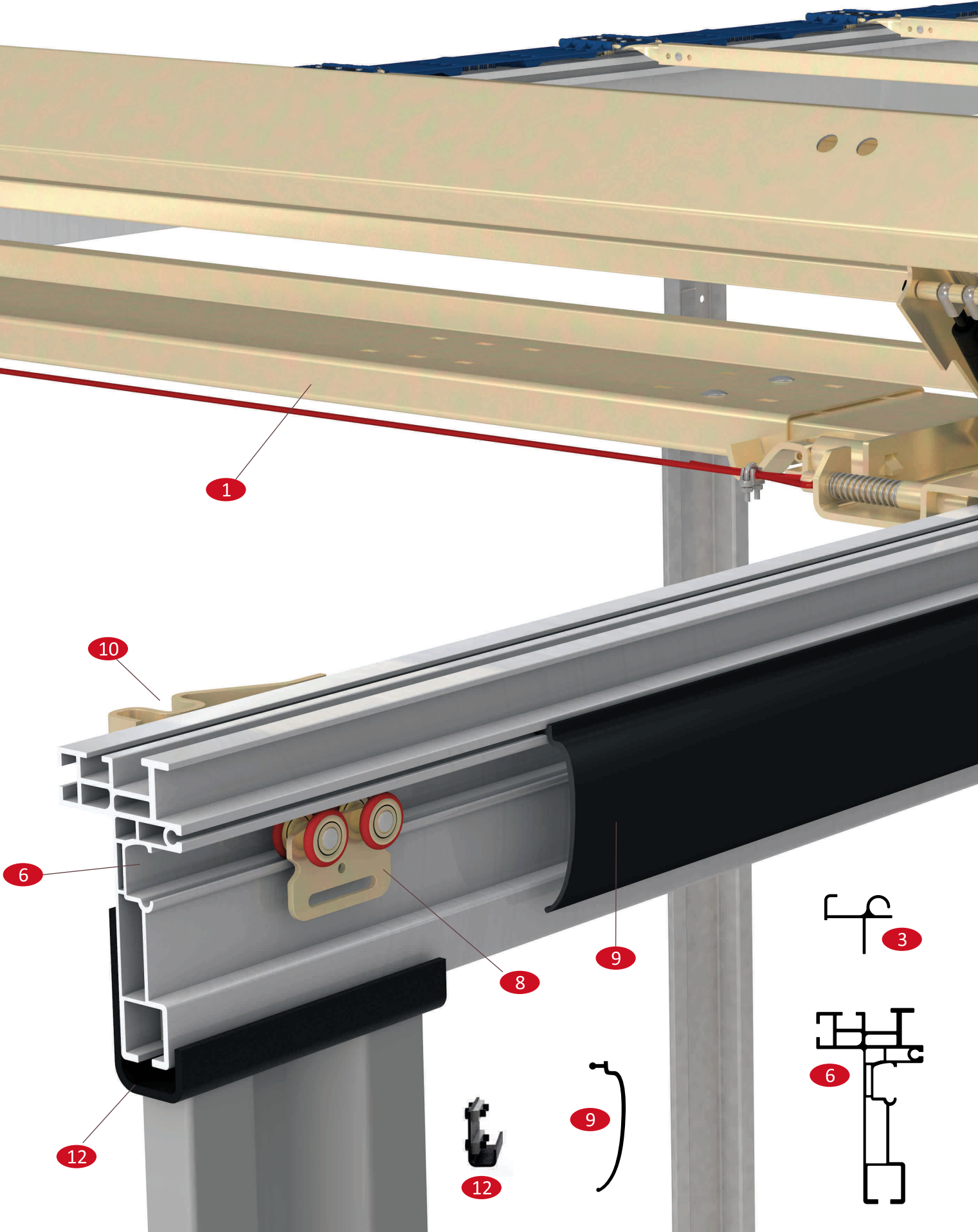

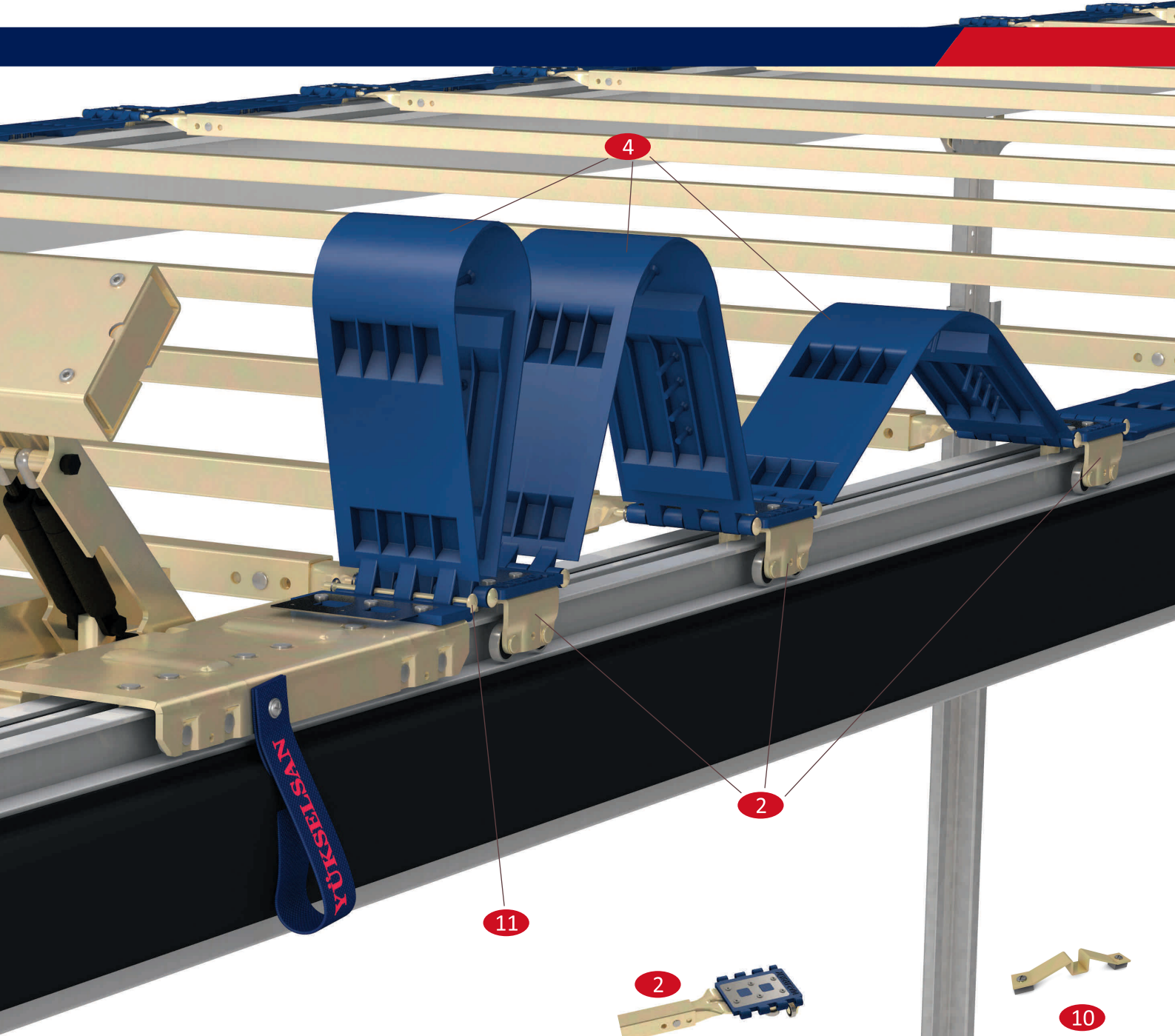

11



10

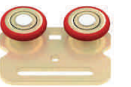
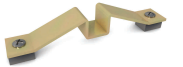

8



7

- 1 Sürme Arabası
- 2 Rulmanlı Kayar Ayak
- 3 Yağmur Oluğu
- 4 Katlanabilir Plastik Levha
- 5 Çatı Açma/Kapama Bastonu
- 6 Sistem Profili
- 7 Kayar Baba Makarası
- 8 Branda Makarası
- 9 Yağmur Lastiği
- 10 Araba Kilit Yuvası
- 11 Pim ve Segman
- 12 Profil Bağlantı Ayağı
- 13 Ön Zincir Ayar Aparatı



13



11



4



5





**YÜKSELSAN**  
KAYAR ÇATI SİSTEMLERİ ve AKSESUARLARI

## 165 Profil (Kalın Seri) Üst Açılır, Yan Açılır Çatı Sistemi

Rulmanlı Kayar Ayak

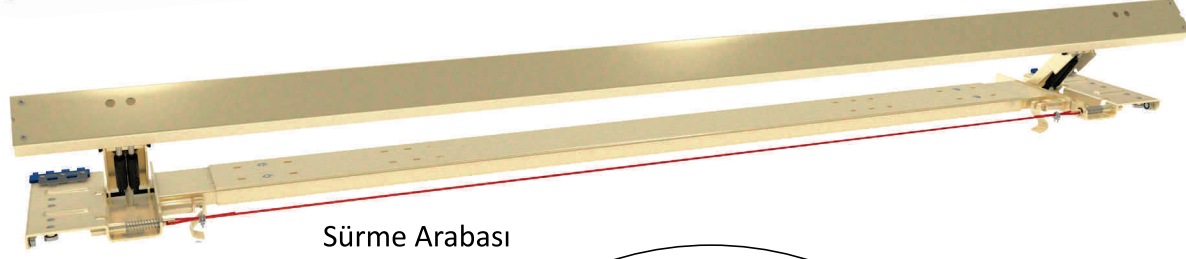
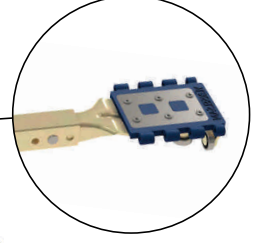

Sürme Arabası



Ön Zincir Ayar Aparatı

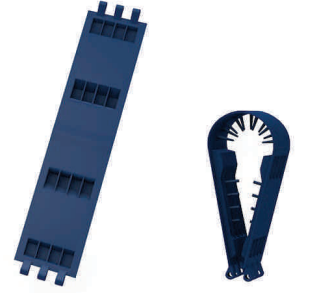

Katlanabilir Plastik Levha



Pim ve Segman



4 Rulmanlı Branda Makarası

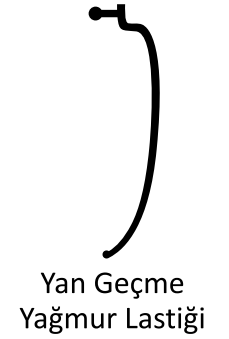

Yan Geçme Yağmur Lastiği



Profil Bağlantı Ayağı



Yağmur Oluğu

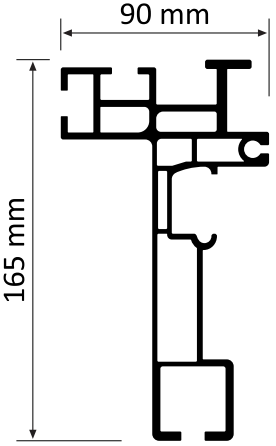

165 mm

90 mm

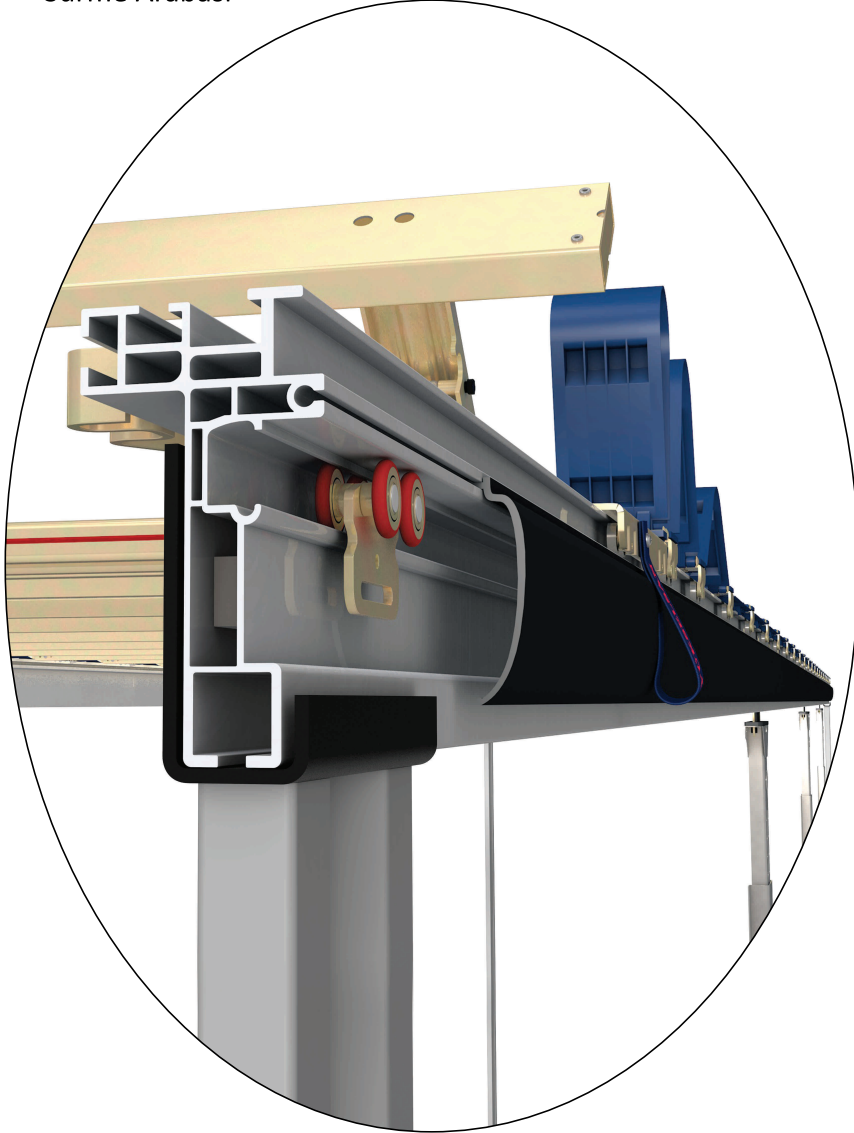

Araba Kilit Yuvası



Kayar Baba Makarası

Çatı Açma/Kapama Bastonu





**YÜKSELSAN**  
KAYAR ÇATI SİSTEMLERİ ve AKSESUARLARI

## 165 Profil Üst Açılır, Yan Açılır Çatı Sistemi

Rulmanlı Kayar Ayak

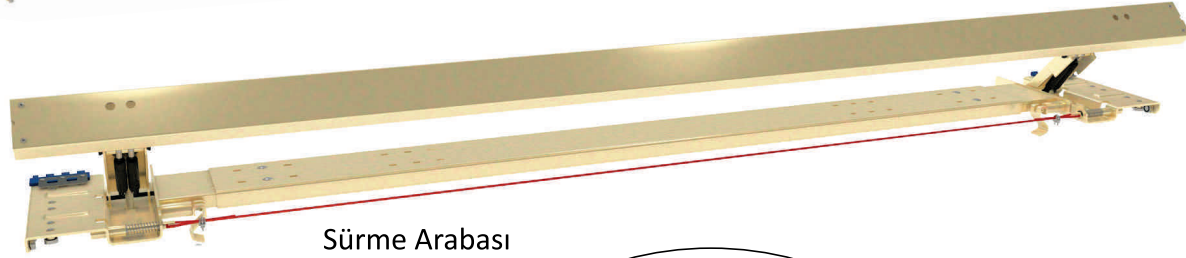
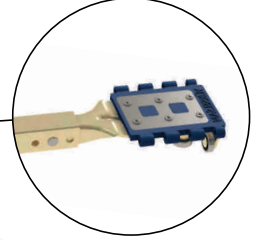

Sürme Arabası



Ön Zincir Ayar Aparatı

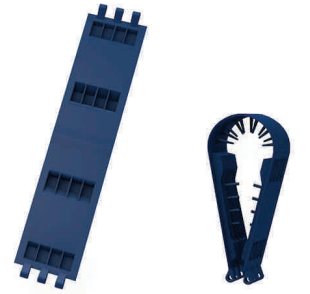

Katlanabilir Plastik Levha



Pim ve Segman



Branda Makarası



Yağmur Oluğu

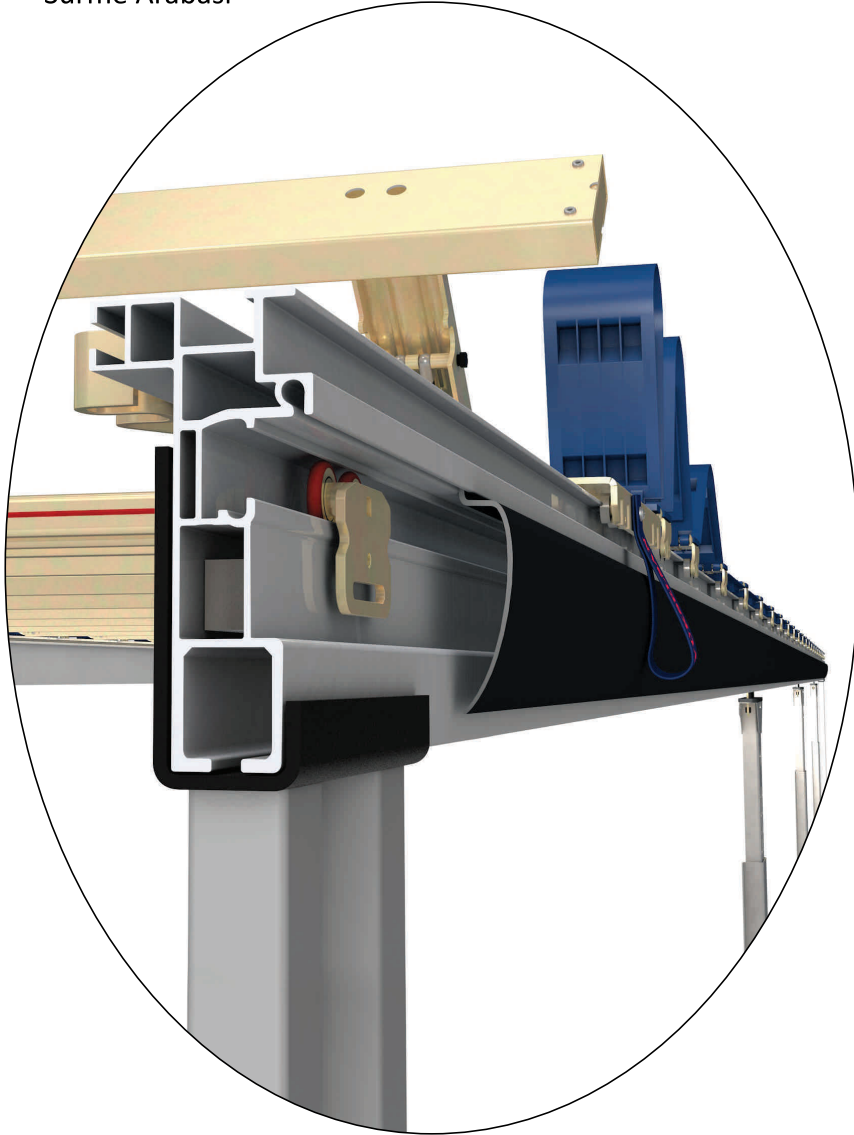
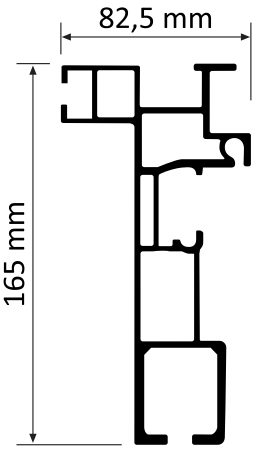

Araba Kilit Yuvası



Kayar Baba Makarası



Tepe Geçme Yağmur Lastiği

Çatı Açma/Kapama Bastonu



Profil Bağlantı Ayağı



**YÜKSELSAN**  
KAYAR ÇATI SİSTEMLERİ ve AKSESUARLARI

## 125 Profil Üst Açılır, Yan Açılır Çatı Sistemi

Rulmanlı Kayar Ayak



Sürme Arabası

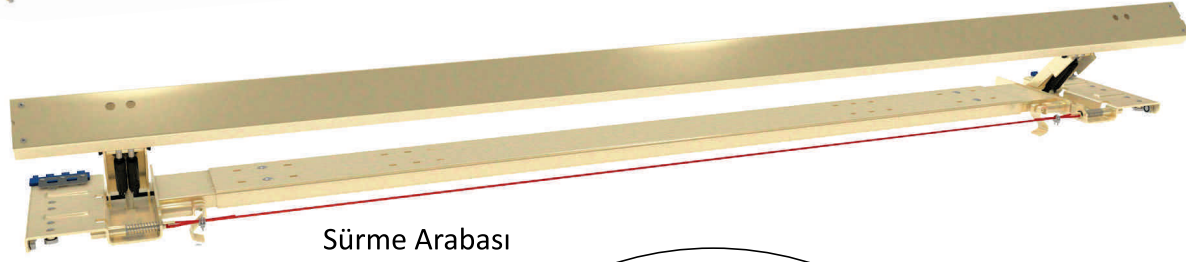

Yağmur Oluğu

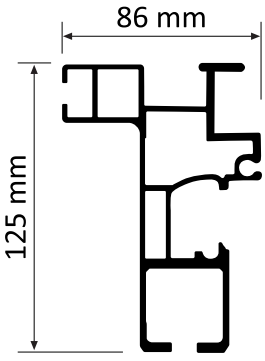

86 mm

125 mm



Araba Kilit Yuvası



Kayar Baba Makarası

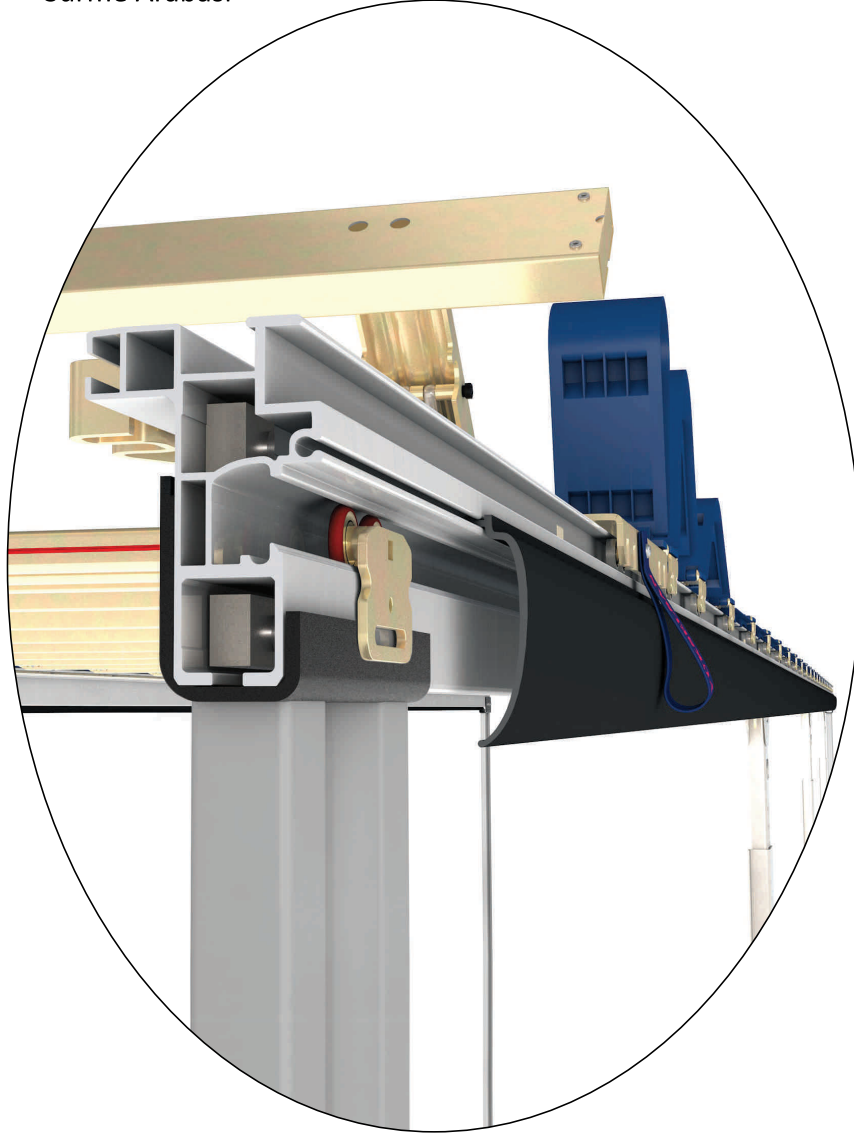

Ön Zincir Ayar Aparatı

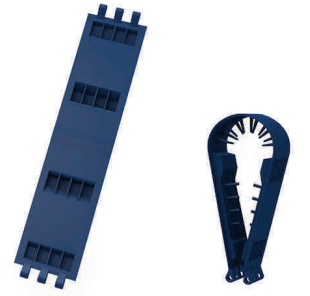

Katlanabilir Plastik Levha



Pim ve Segman



Branda Makarası



Yan Geçme Yağmur Lastiği



Çatı Açma/Kapama Bastonu



Profil Bağlantı Ayağı



**YÜKSELSAN**  
KAYAR ÇATI SİSTEMLERİ ve AKSESUARLARI

## 105 Profil Üst Açılır, Yan Açılır Çatı Sistemi

Rulmanlı Kayar Ayak

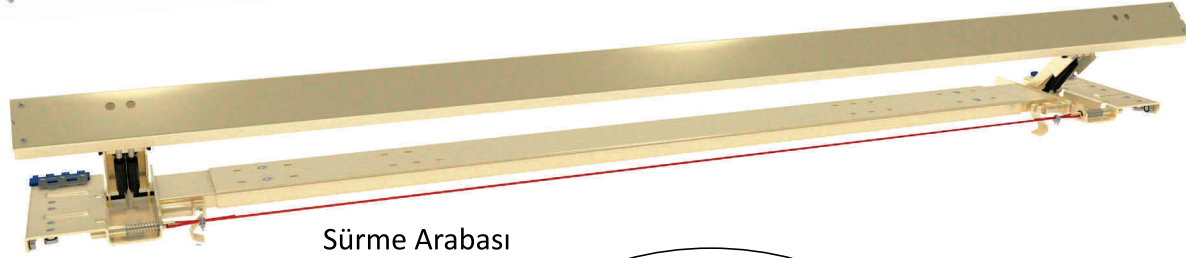
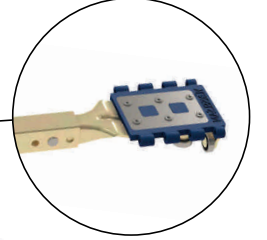

Sürme Arabası



Ön Zincir Ayar Aparatı

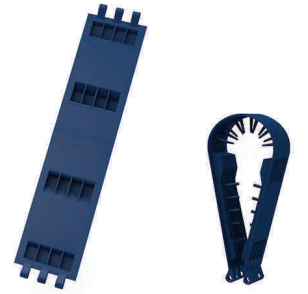

Katlanabilir Plastik Levha



Pim ve Segman



Branda Makarası



Yağmur Oluğu

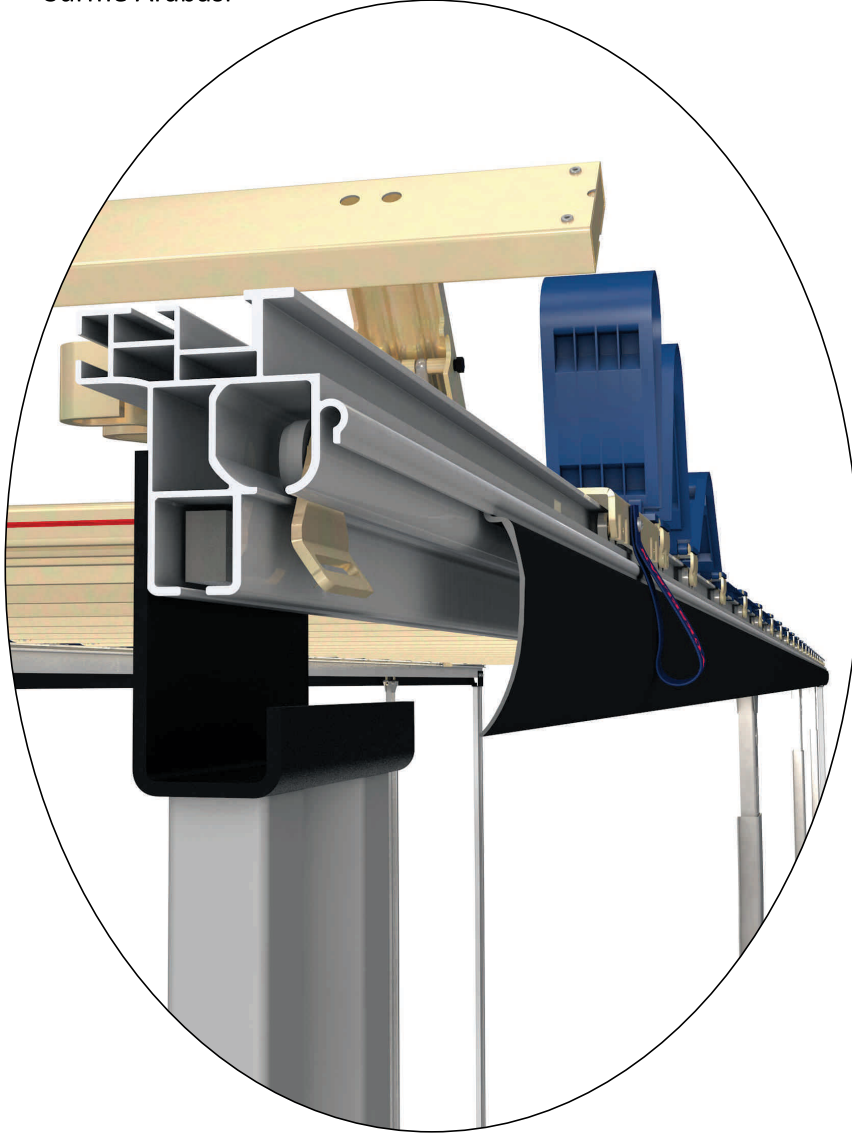
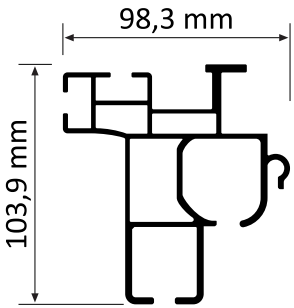

Araba Kilit Yuvası



Kayar Baba Makarası

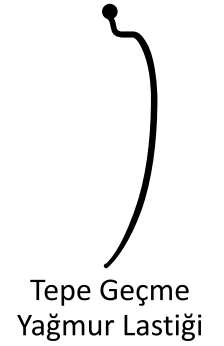

Tepe Geçme Yağmur Lastiği



Profil Bağlantı Ayağı

Çatı Açma/Kapama Bastonu





**YÜKSELSAN**  
KAYAR ÇATI SİSTEMLERİ ve AKSESUARLARI

## 90 Profil Üst Açılır, Yan Açılır Çatı Sistemi

Rulmanlı Kayar Ayak



Sürme Arabası

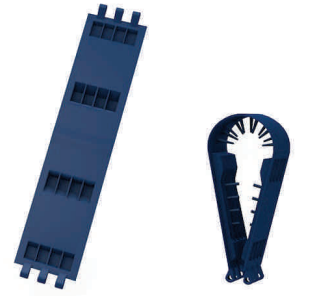
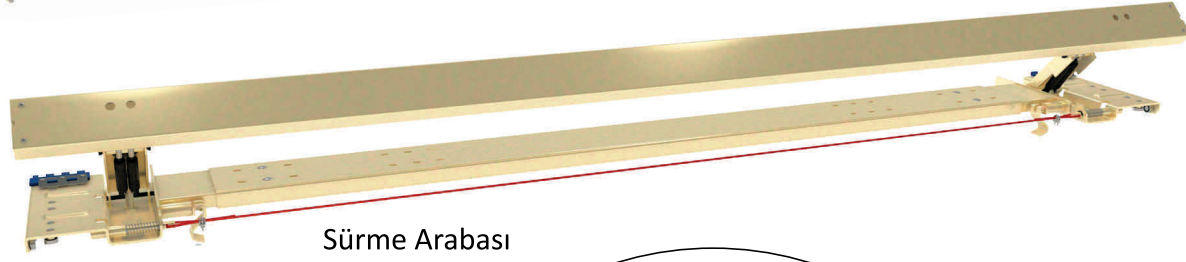

Katlanabilir  
Plastik Levha

Pim ve Segman



Branda Makarası



Yan Geçme  
Yağmur Lastiği

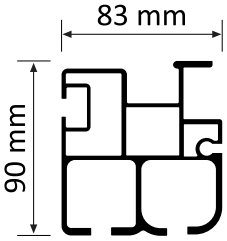

Araba Kilit Yuvası



Z Tipi  
Kayar Baba  
Makarası

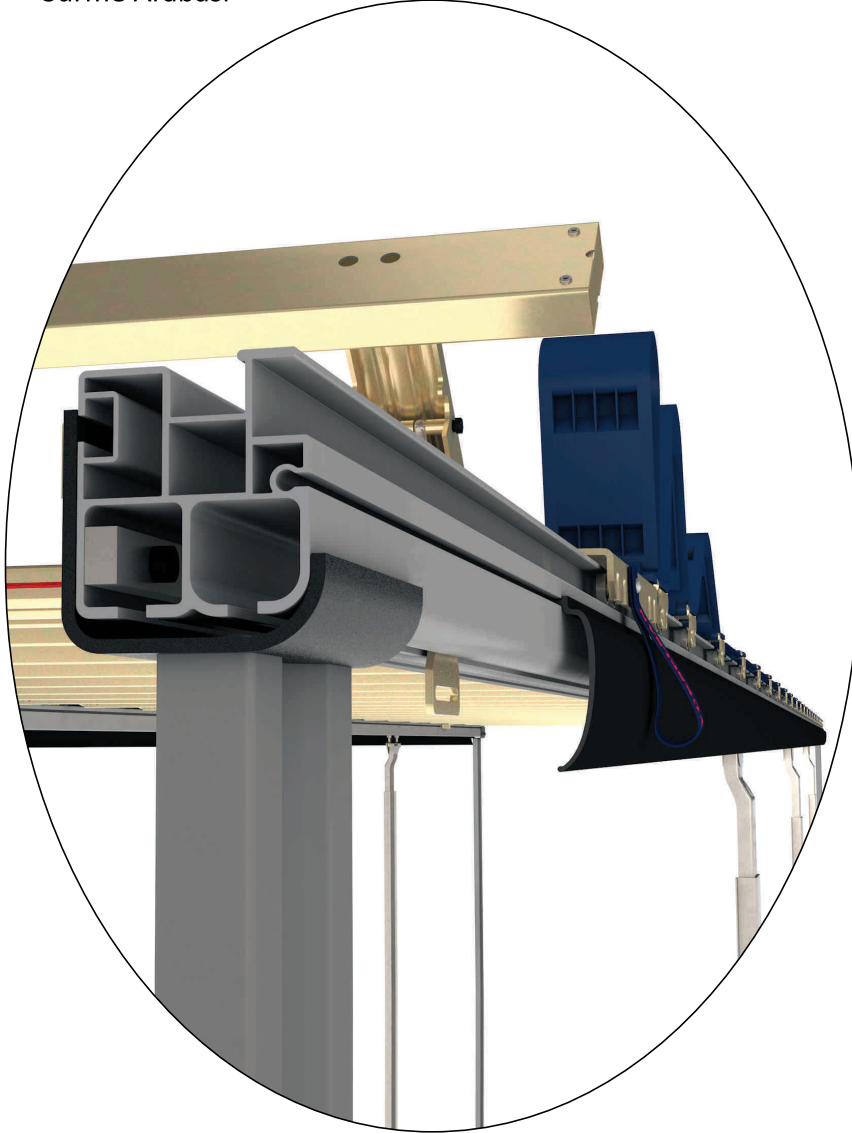

Çatı Açma/Kapama Bastonu



Profil  
Bağlantı Ayağı



**YÜKSELSAN**  
KAYAR ÇATI SİSTEMLERİ ve AKSESUARLARI

## Üst ve Yan Birlikte Açılır Çatı Sistemi

Rulmanlı Kayar Ayak

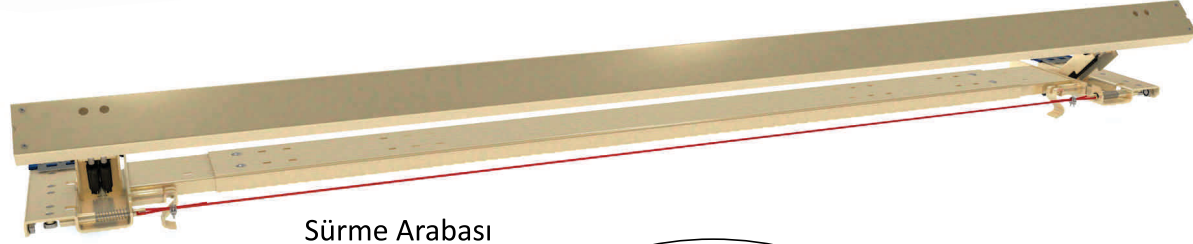

Sürme Arabası  
(Dar Tip)



Ön Zincir  
Ayar Aparatı



Yağmur  
Oluğu

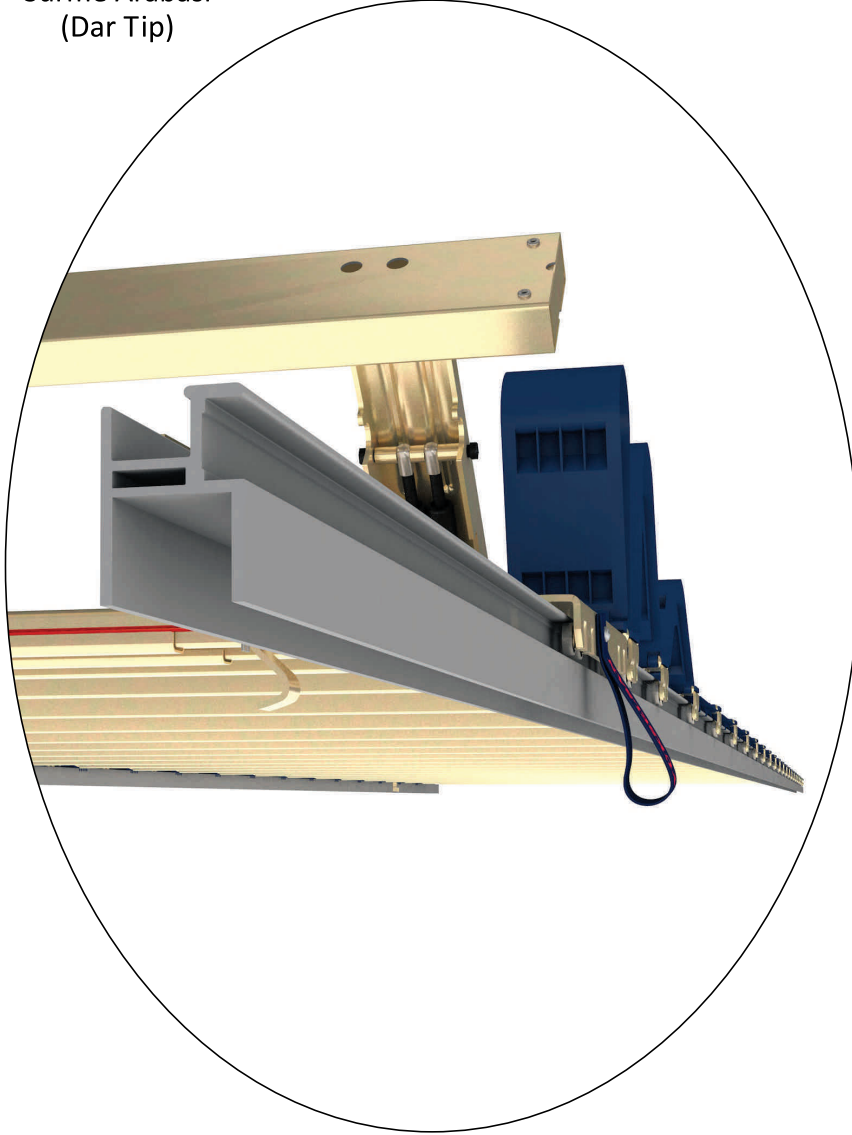

Katlanabilir  
Plastik Levha



Pim ve Segman

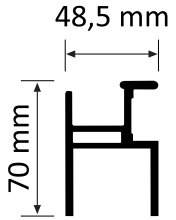

48,5 mm  
70 mm



Düz Saclı  
Araba Kilit Yuvası



Çatı Açma/Kapama Bastonu



**YÜKSELSAN**  
KAYAR ÇATI SİSTEMLERİ ve AKSESUARLARI

## 125 Profil Üst Sabit, Yan Açılır Çatı Sistemi

Üst Sabit, Yan Açılır Çatı Sistemi  
tüm profillere uyarlanabilmektedir.

Sabit Ayak

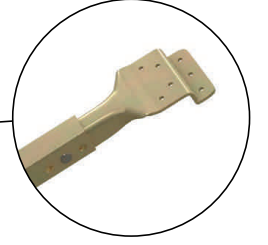

Yağmur  
Oluğu

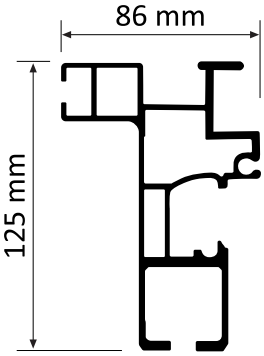

125 mm

86 mm



Branda Makarası



Yan Geçme  
Yağmur Lastiği



Kayar Baba  
Makarası



Profil  
Bağlantı Ayağı



**YÜKSELSAN**  
KAYAR ÇATI SİSTEMLERİ ve AKSESUARLARI

## Üst Sabit, Yan Açılır Çatı Sistemi

Sabit Ayak

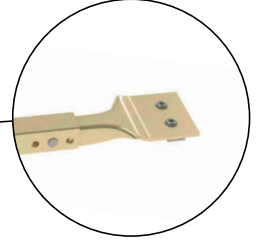

Yağmur  
Oluğu

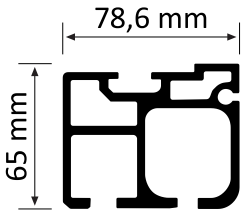

Branda Makarası



Yan Geçme  
Yağmur Lastiği



Z Tipi  
Kayar Baba  
Makarası



Profil  
Bağlantı Ayağı



**YÜKSELSAN**  
ÇADIR - BRANDA - DORSE AKSESUARLARI

## Gergi Lastikleri, Aparatları ve Kancaları

### Gergi Aparatları ve Gergi Kancaları



Plastik  
Lastik Kancası



Plastik  
S Kanca



Metal  
S Kanca



Yaylı  
Kanca



Orijinal  
Gergi aparatı



Açık  
Gergi aparatı



Sac Takviyeli  
Gergi aparatı

### Tekli Lastikler

6 - 7 - 8 mm / 22 - 27 - 50 - 60 cm  
Plastik veya Çelik Kancalı veya Kancasız

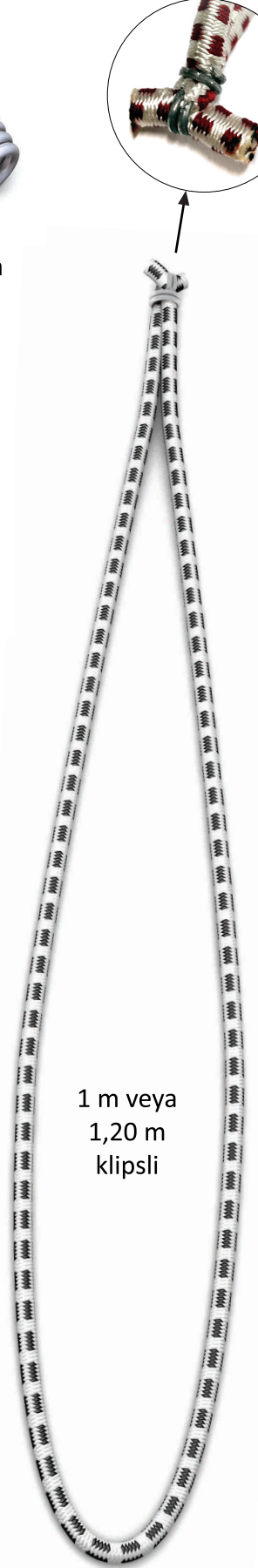

1 m veya  
1,20 m  
klipsli



**YÜKSELSAN**  
ÇADIR - BRANDA - DORSE AKSESUARLARI

## Gergi Lastikleri, Aparatları ve Kancaları

### 1. Kalite Lateks Üzeri Örgü Lastikler

**Monofilament Örgü,  
Teknik Polyester Örgü**  
6 ve 8 mm Lastikler  
150 / 300 m. Top (İthal)

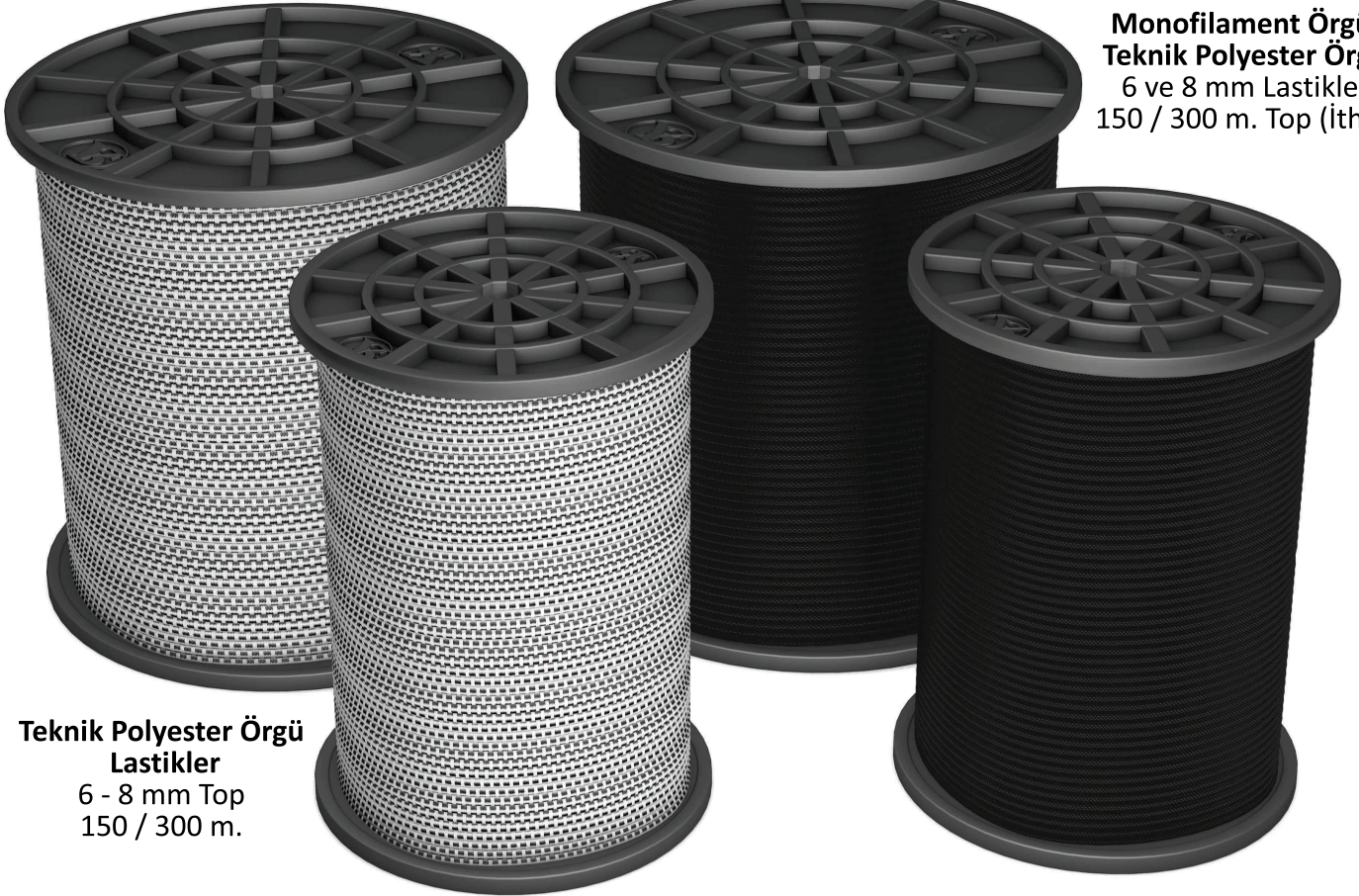

**Teknik Polyester Örgü  
Lastikler**  
6 - 8 mm Top  
150 / 300 m.



**Çadır Branda Lastiği**  
(50 m.)



**Monofilament**  
(14 m.)



**Uç Sabitleme  
Aparatı**



**YÜKSELSAN**  
ÇADIR - BRANDA - DORSE AKSESUARLARI

## Delme ve Çakma Kalıpları



Oval Kapsül  
Delgi Kalıbı



40 No. Kapsül  
Delgi Kalıbı



31 No. Kapsül  
Delgi Kalıbı



28 No. Kapsül  
Delgi Kalıbı



24 No. Kapsül  
Delgi Kalıbı

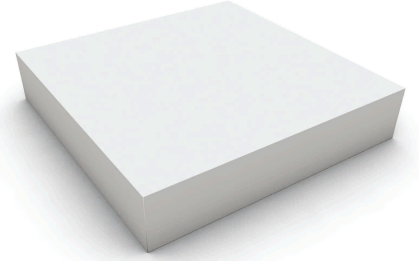

Polyamid Delgi Takozu  
250 x 250 x 50 mm.

Oval Kapsül  
Çakma Kalıbı

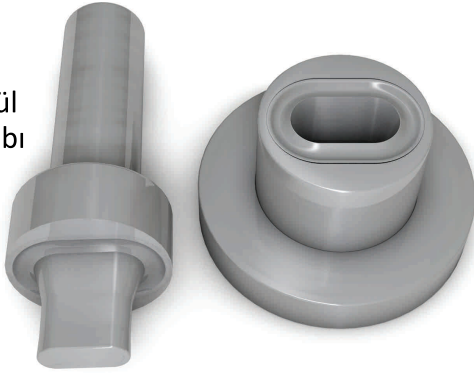

40 No. Kapsül  
Çakma Kalıbı

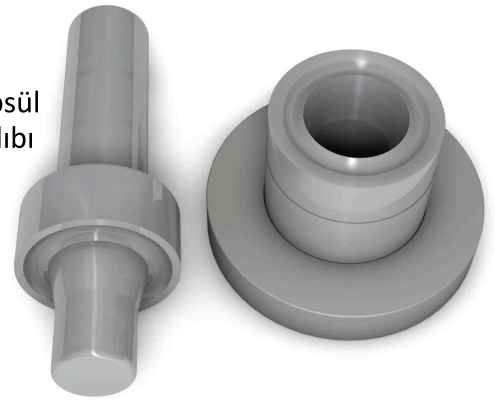

31 No. Kapsül  
Çakma Kalıbı



28 No. Kapsül  
Çakma Kalıbı



24 No. Kapsül  
Çakma Kalıbı



Plastik  
Gergi Aparatı  
Delgi Kalıbı



Toka Sabitleme  
Laması  
Delgi Kalıbı



Köprü  
Takviye Sacı  
Delgi Kalıbı



Köprü  
Takviye Sacı  
Çakma Kalıbı



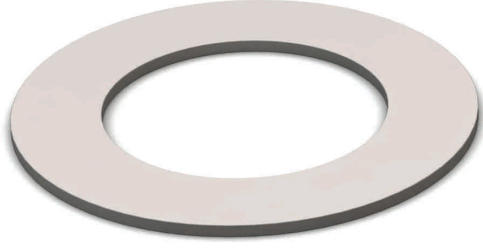

Kapsül Contaları



40 No. Kapsül



42-22 No. Kapsül



42-8 No. Kapsül



31 No.  
Kapsül



28 No.  
Kapsül



24 No.  
Kapsül



Çatı Kapsülü  
Büyük boy



Çatı Kapsülü  
Küçük boy



**YÜKSELSAN**  
ÇADIR - BRANDA - DORSE AKSESUARLARI

## Köprü Kancalar



**Döner Köprü**  
Metal



**Döner Köprü**  
Plastik



**Kare Flanşlı Kapak Kancası**  
(4 delikli)



**Dorse Kapak Kancası**  
Geniş Aralık 67 mm



**Yerli Tip Kapak Kancası**  
35 mm

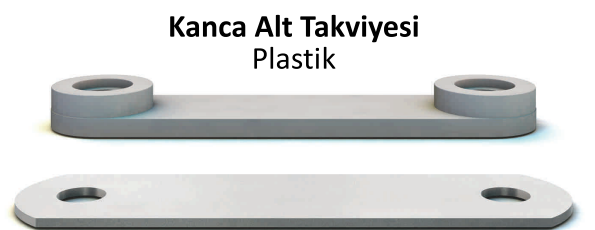

**Kanca Alt Takviyesi**  
Plastik

**Kanca Alt Takviyesi**  
Sac

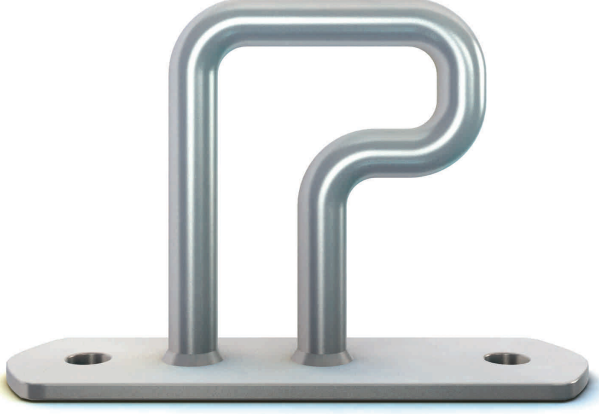

**Dorse Kapak Kancası**  
P Tipi



**Avr. Tip - Dorse**  
**Kapak Kancası**  
32 mm



**Kare Flanşlı**  
**Kapak Kancası**  
35 mm



**Avr. Tip - Dorse**  
**Kapak Kancası**  
30 mm



**Kare Flanşlı**  
**Kapak Kancası**  
30 mm



**Avr. Tip - Dorse**  
**Kapak Kancası**  
25 mm



**YÜKSELSAN**  
ÇADIR - BRANDA - DORSE AKSESUARLARI

## Köprü Kancalar



**Avr. Tip Oynarlı Kapak Kancası**  
Tek Parça

37 mm



25 mm



**Avr. Tip Oynarlı Kanca**  
2 Parça

37 mm



25 mm



**Oynarlı Kanca Teli**  
(6 mm)





**Branda Kayış Kancası**  
40 mm



**Branda Kayış Kancası**  
35 mm



**Branda Kayış Kancası**  
30 mm



**Branda Kayış Kancası**  
25 mm



**Branda Kayış Kancası**  
20 mm



**Branda Kayış Kancası**  
15 mm



**YÜKSELSAN**  
ÇADIR - BRANDA - DORSE AKSESUARLARI

## Halat, Kolon, Bant, Kayış

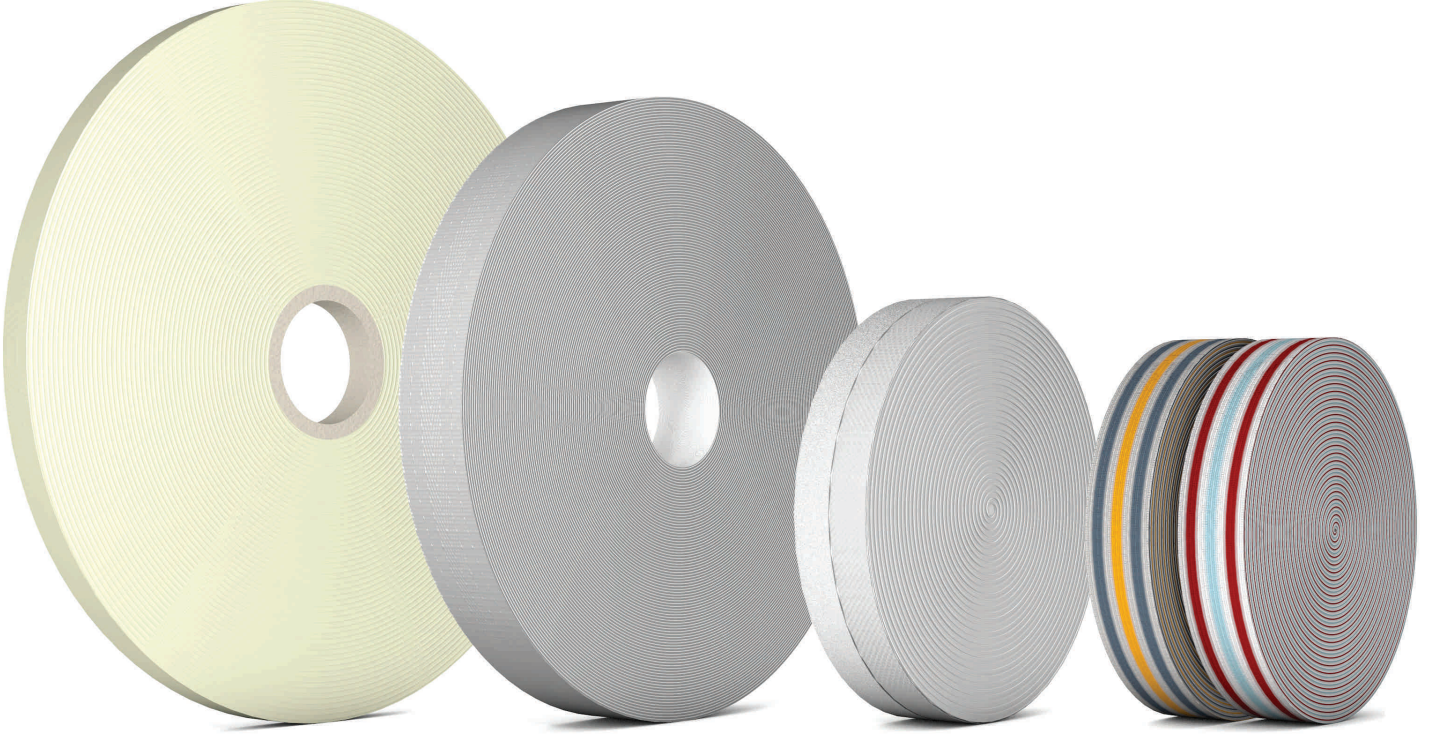

**Kapak Kayışı**  
(İthal - Yerli)

**Yapışabilir**  
**Kolon**

**Cırt Bant**  
2,5 cm

**Çadırıcı**  
**Kolonu**



500 veya  
1.000 m. Top

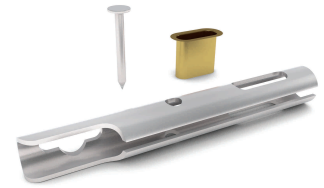

**Halat Başlığı**  
6mm



**Metrajlı**  
**Gümrük Halatı**  
6 mm



**YÜKSELSAN**  
ÇADIR - BRANDA - DORSE AKSESUARLARI

## Toka, Perçin, Fitol, İplik, Fermuar



Plastik Fermuar



Fermuar Kursörü

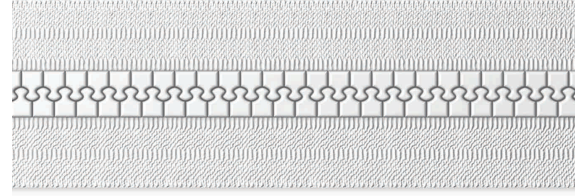

Kemik Fermuar



Multigrip Çelik Perçin



Trok Perçin



Pop Perçin



Dikiş Makinesi İpliği  
20, 30, 36 No



Branda Gergi Fitili  
10 mm

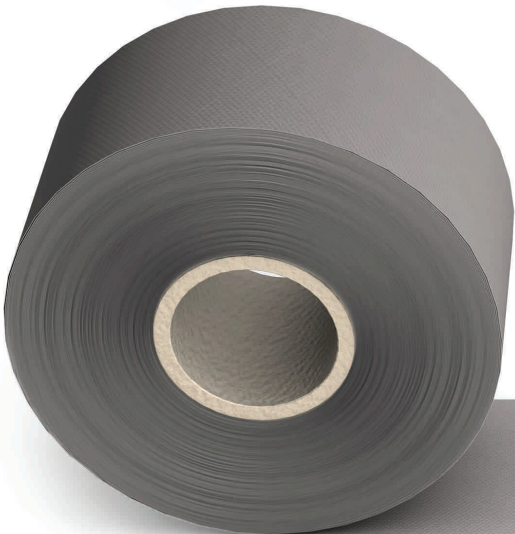

Treyler Çatı Takviyesi  
( 60 m )

Tavan Profili  
Bağlama Tokası ve Kemeri

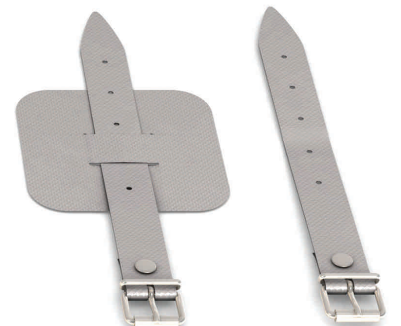
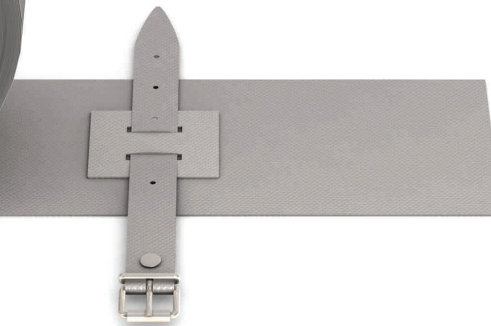



**YÜKSELSAN**  
ÇADIR - BRANDA - DORSE AKSESUARLARI

## Plastik Döner Köprüler

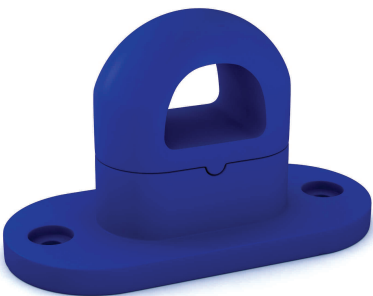
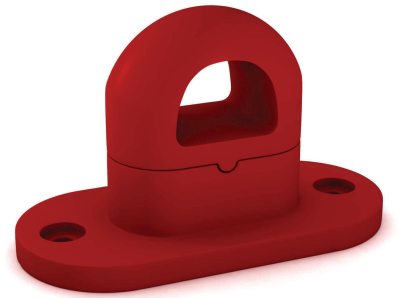
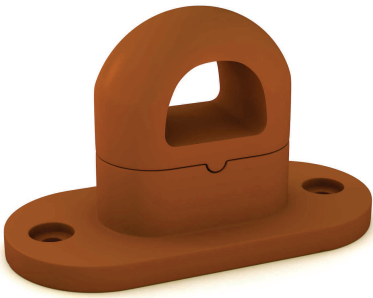
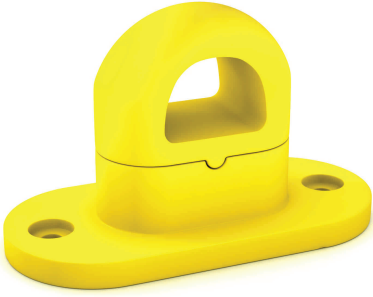



**YÜKSELSAN**  
ÇADIR - BRANDA - DORSE AKSESUARLARI

## Plastik Geçme Tokalar ve Ayar Tokaları

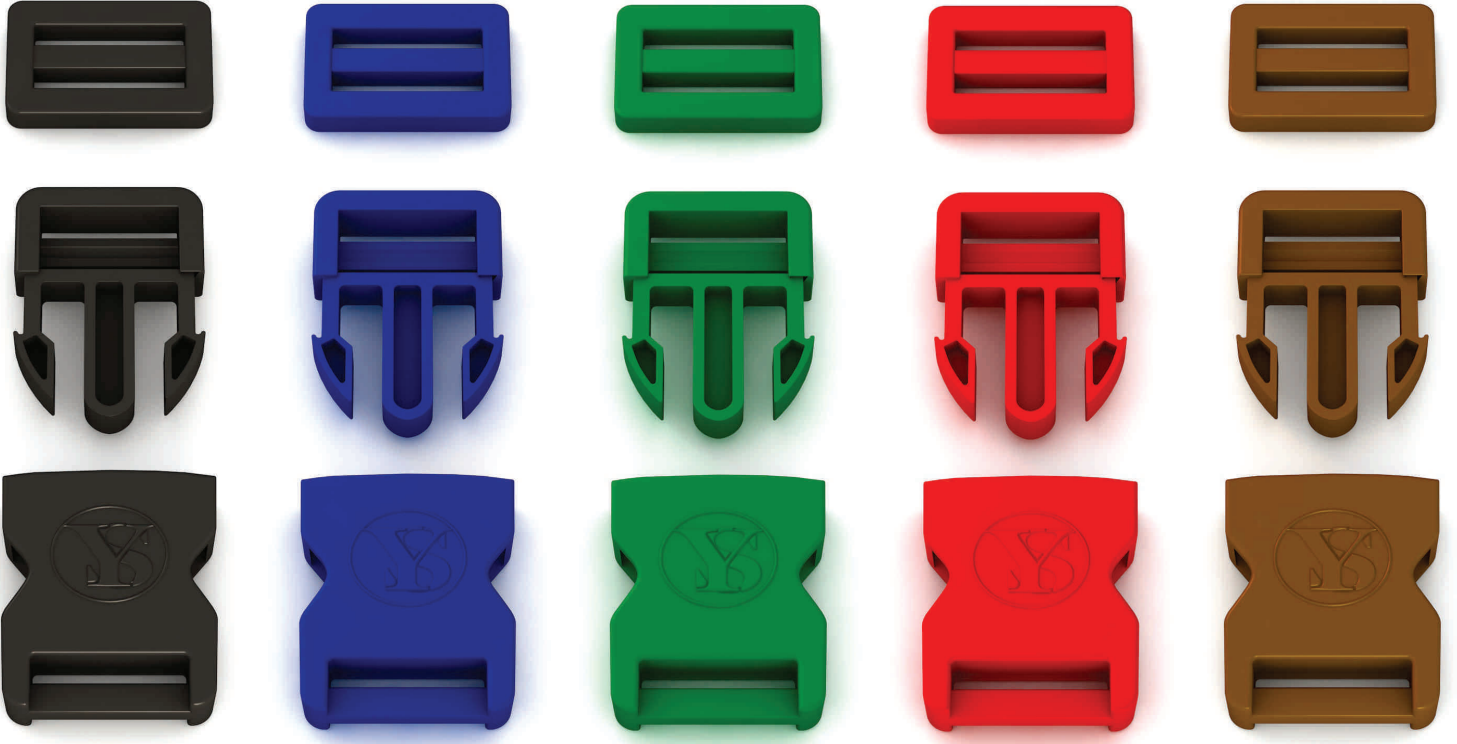

Plastik Geçme Toka ( 3 cm )  
ve Ayar Tokası

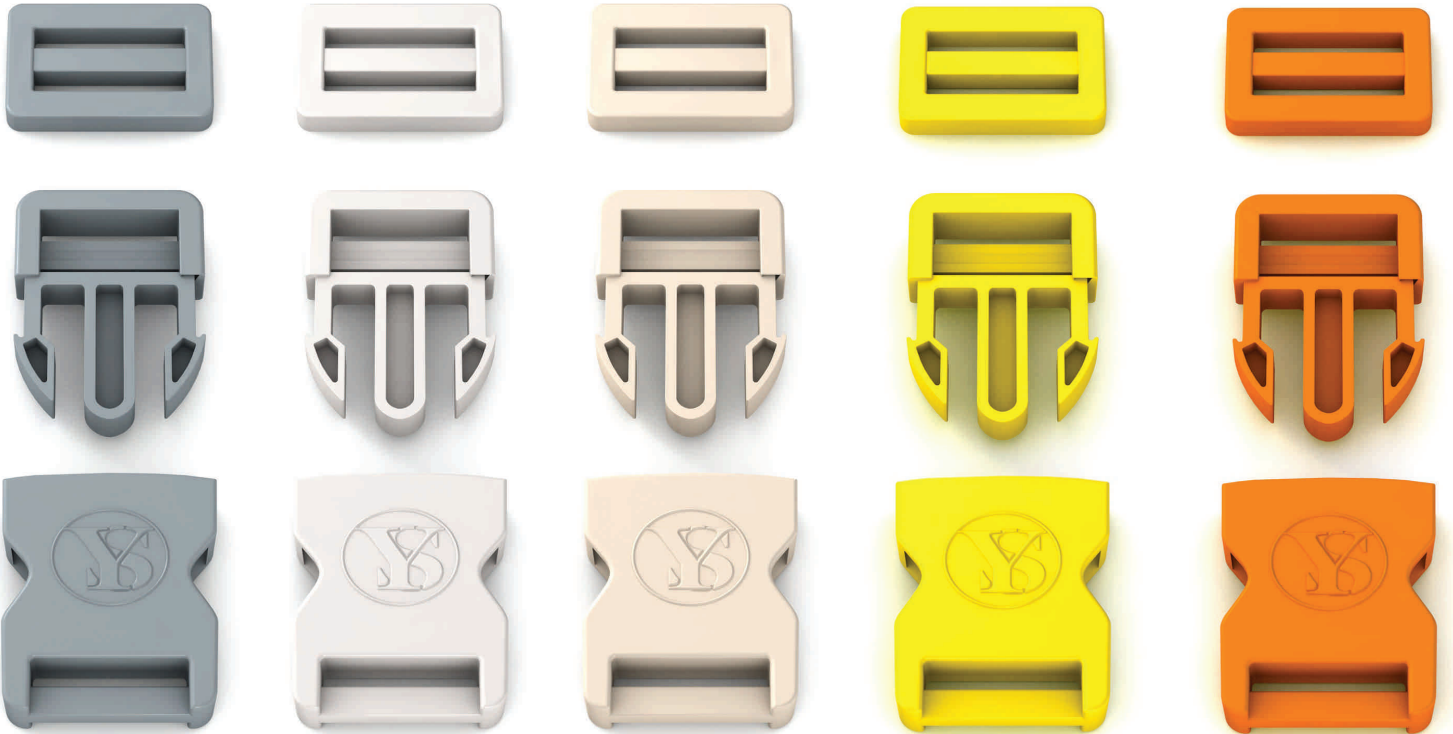



**YÜKSELSAN**  
ÇADIR - BRANDA - DORSE AKSESUARLARI

## Halkalar

### Demir Halkalar

14, 16, 18, 20, 22 no.,  
50, 65 no., 50 no. D Halka

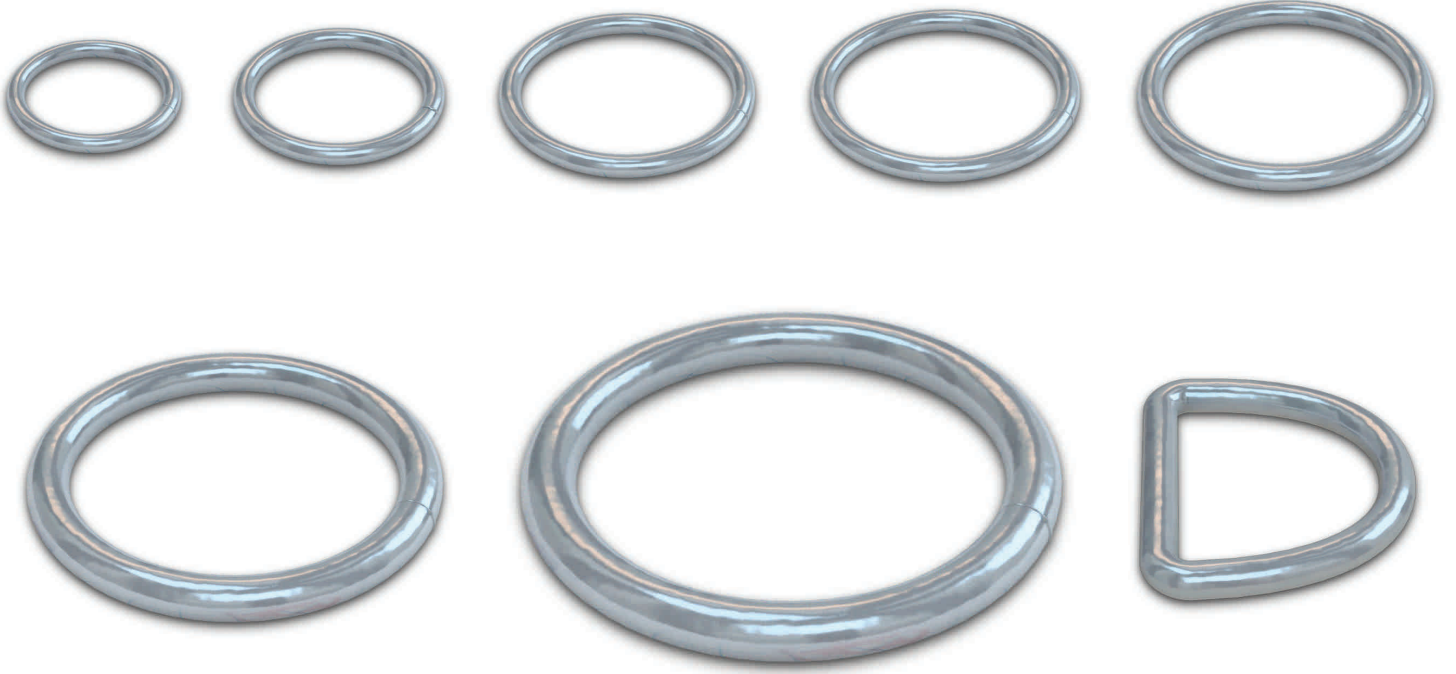

### Plastik Halkalar

30 no., 40 no., 40 no. D Halka





**YÜKSELSAN**  
ÇADIR - BRANDA - DORSE AKSESUARLARI

## Gergi Tokaları, Kancaları ve Kolonları

**Gergi Kolonu**  
50 m.

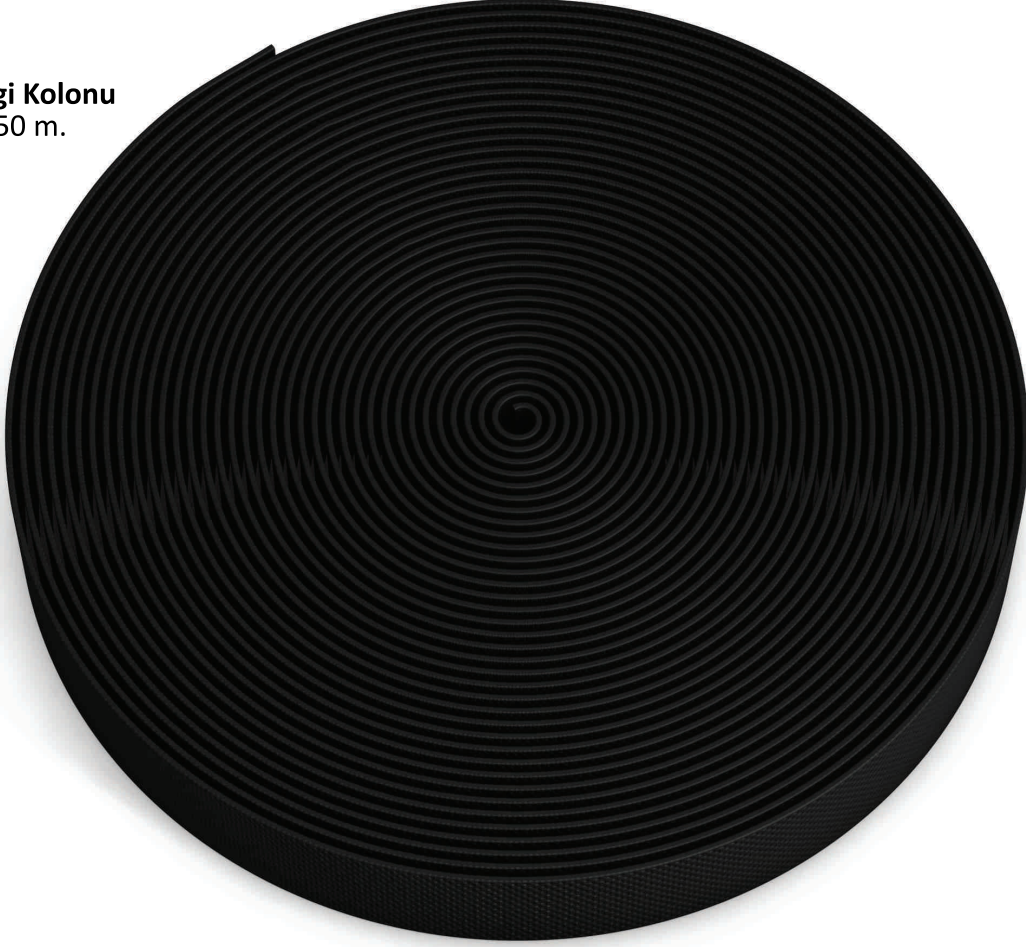

Büyük Toka

### Yan Perde Tokaları



Küçük Toka



Kilitli Toka

### Kolon Dikili Gergi Kancaları



E tip



J tip



Sabitleme Lamaları



Alt Gergi Kancaları



## Makaralar



Dört Tekerlekli,  
Büyük Tip Makara



TSE Tip, Plastik Tekerlekli  
Alt Perde Makarası

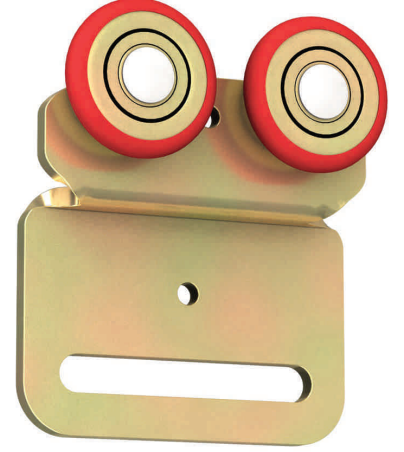

Kolon Geçmeli, Plastik  
Tekerlekli Perde Makarası

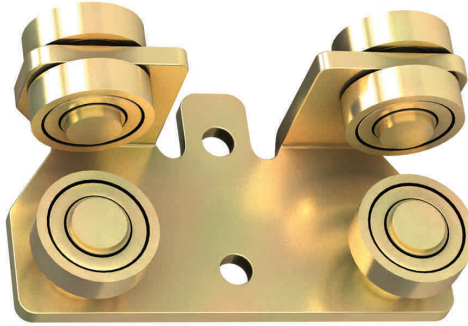

6 Rulmanlı Makara



Metal Tekerlekli,  
Kayar Baba Makarası

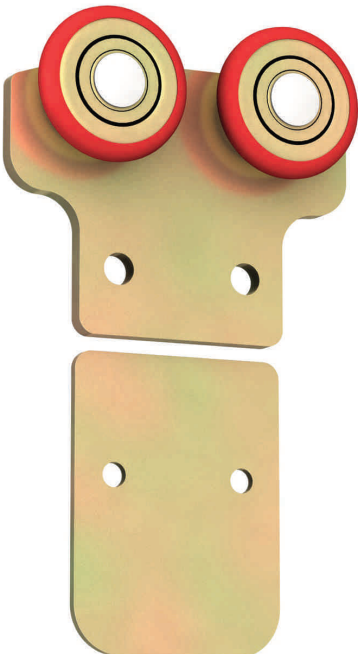

Perçinli Makara

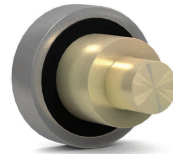

Pimli Rulman

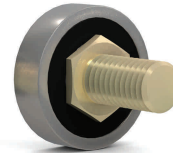

Vidalı Rulman

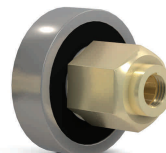

6 Köşeli Rulman



Plastik Tekerlekli,  
Kayar Baba Makarası



## Makaralar



Plastik Tekerlekli,  
Eğri Saplı Makara

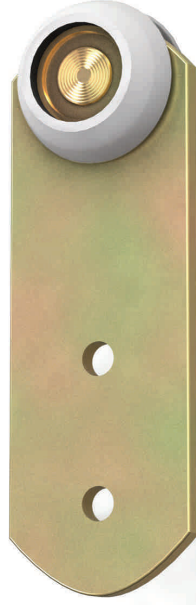

Plastik Tekerlekli,  
Düz Saplı Makara



Çelik Tekerlekli,  
Eğri Saplı Makara



Çelik Tekerlekli,  
Düz Saplı Makara



Kolon Geçmeli, Plastik  
4 Tekerlekli Perde Makarası



Kolon Geçmeli, Plastik  
Tekerlekli Perde Makarası



Kolon Geçmeli, Metal  
Tekerlekli Perde Makarası



Plastik Tekerlekli, Üçgen  
Üst Perde Makarası



Plastik Tekerlekli, Destekleme  
Lamalı Üçgen Makara



Plastik Tekerlekli, Üçgen  
Eğri Saplı Makara



**YÜKSELSAN**  
ÇADIR - BRANDA - DORSE AKSESUARLARI

## 27 mm Gergi Adaptörleri

27 mm C tipi  
Standart Alt Adaptör

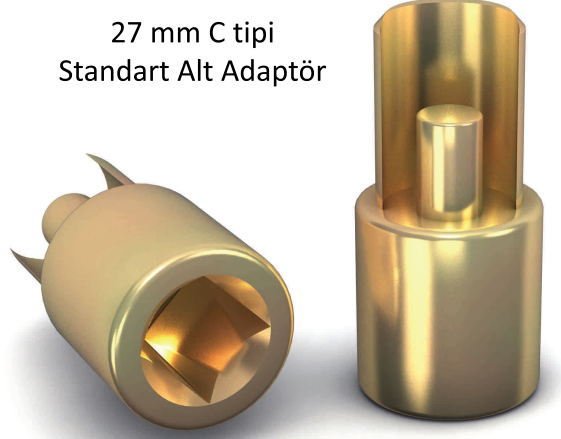

27 mm Yuvarlak Tip  
Alt Adaptör

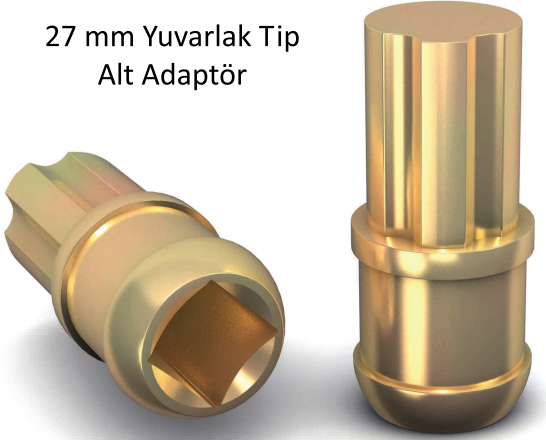

27 mm C tipi  
Üst Adaptör

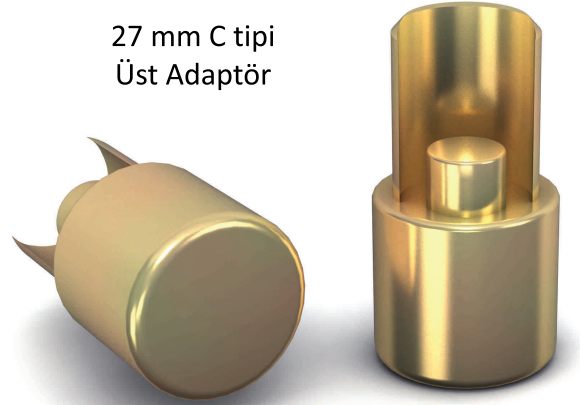

27 mm Yuvarlak Tip  
Özel Yapım Adaptör

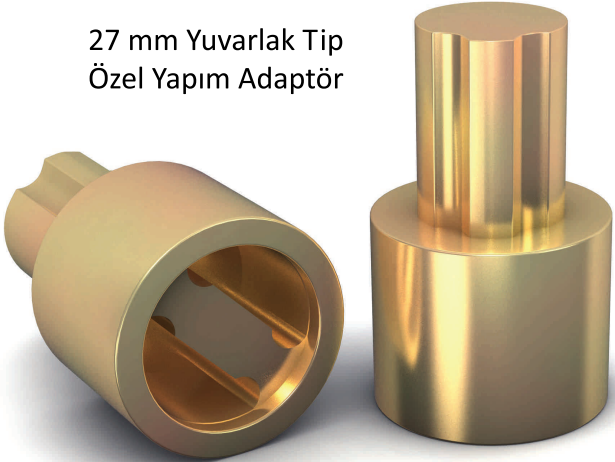

27 mm Özel  
Alt Adaptör

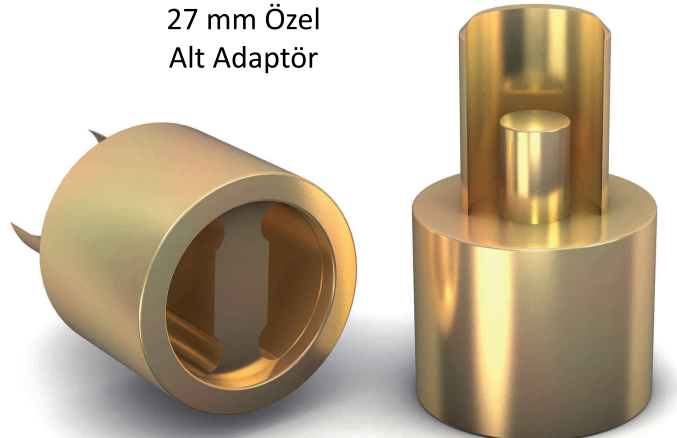



## 34 mm Gergi Adaptörleri

34 mm Standart  
Alt Adaptör

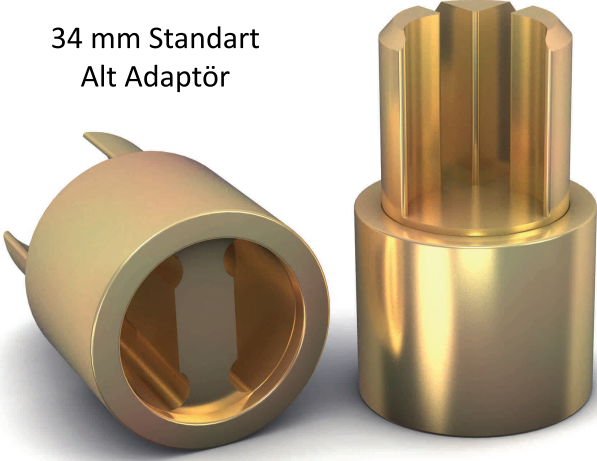

34 mm Özel  
Yapım Adaptör

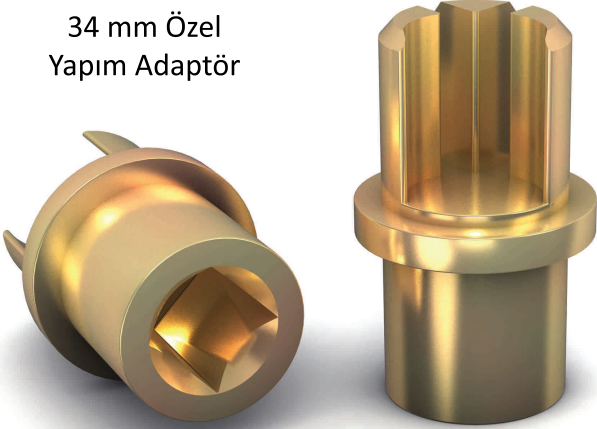

34 mm Uzun  
Saplı Adaptör

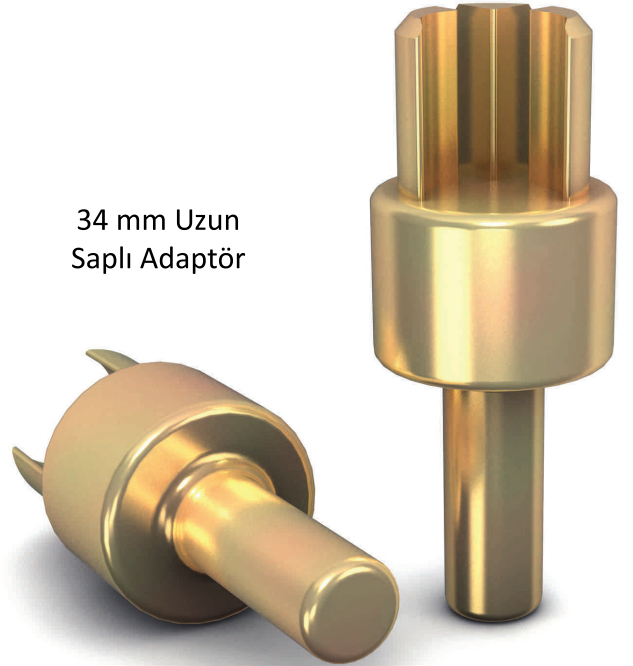

34 mm Standart  
Üst Adaptör

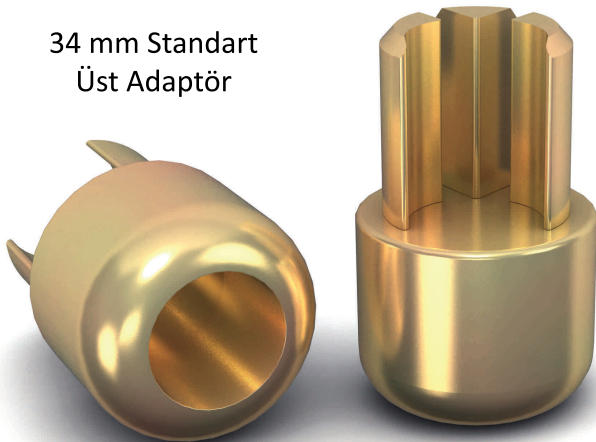

34 mm  
Lama Adaptör

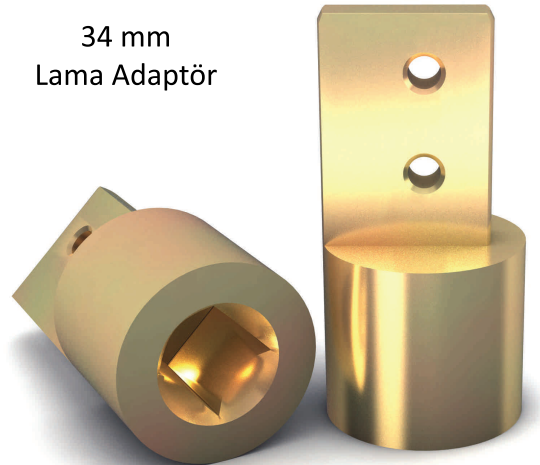



**YÜKSELSAN**  
ÇADIR - BRANDA - DORSE AKSESUARLARI

## Gergi Sistemi



Üst Adaptör



Sarma Borusu



Alt Adaptör



Gergi Mekanizması

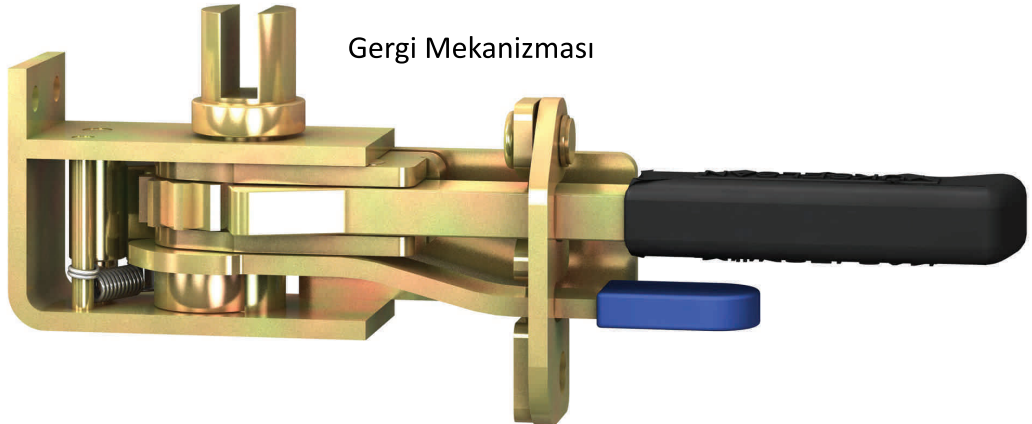



**YÜKSELSAN**  
ÇADIR - BRANDA - DORSE AKSESUARLARI

## Gergi Mekanizmaları

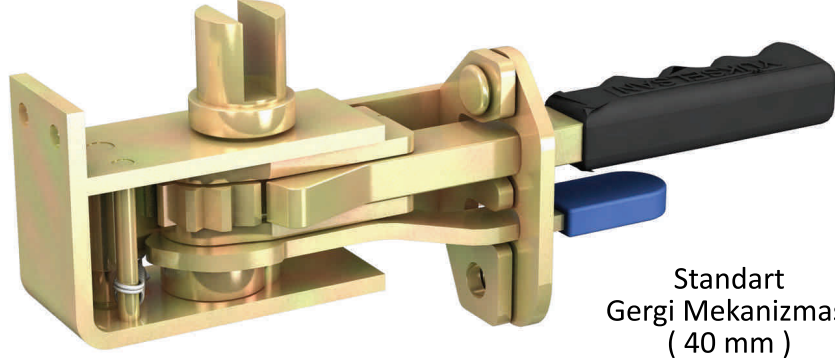

Standart  
Gergi Mekanizması  
( 40 mm )

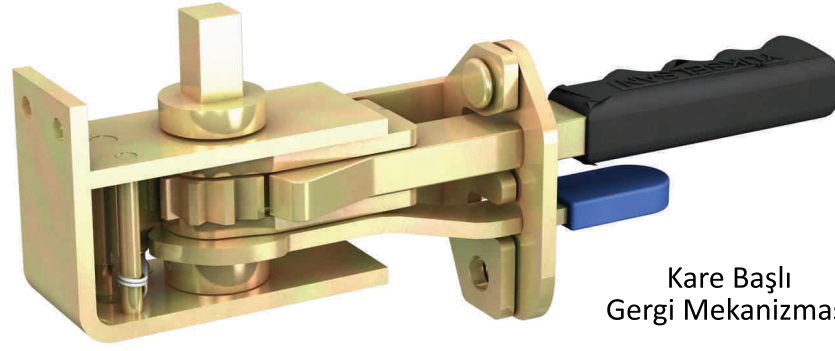

Kare Başlı  
Gergi Mekanizması

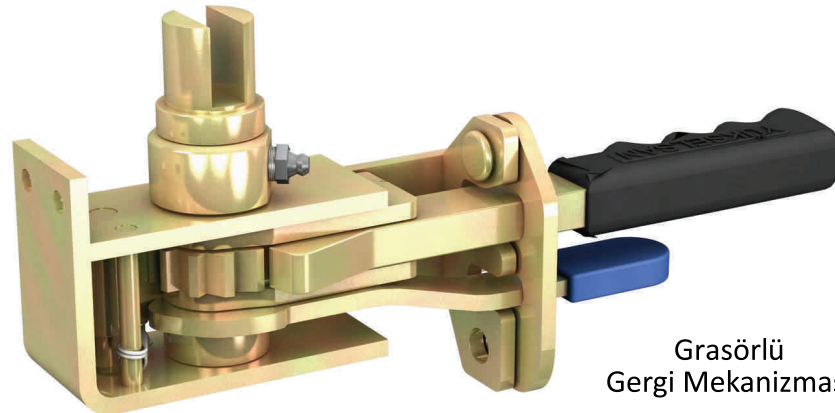

Grasörlü  
Gergi Mekanizması



## Sistem Profilleri



165 Profil (Kalın Seri)



165 Profil



125 Profil

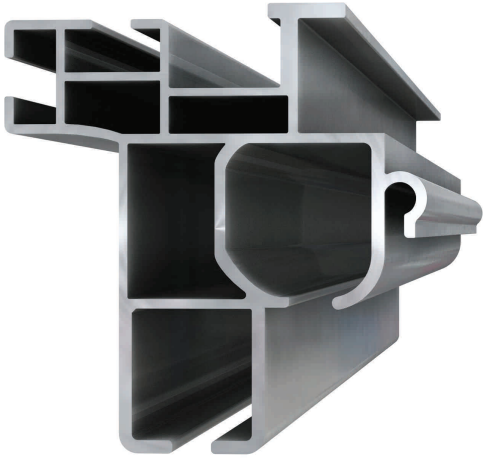

105 Profil

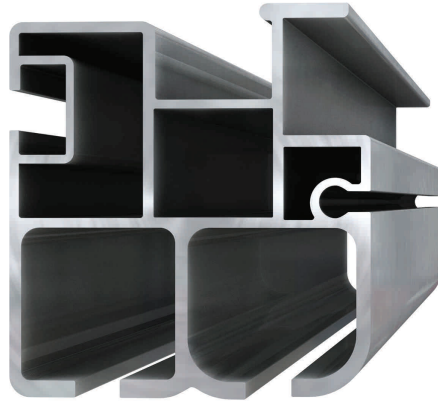

90 Profil

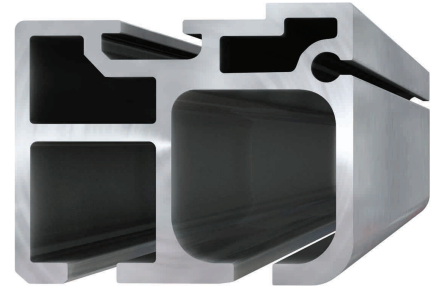

Sabit Çatı  
Profili

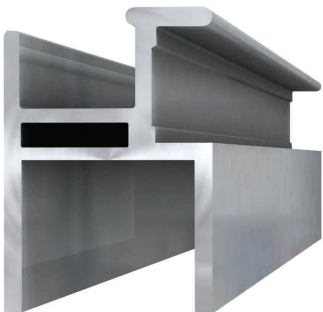

Tulum Kayar  
Profili

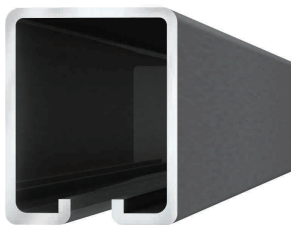

Çelik  
Baba Rayı

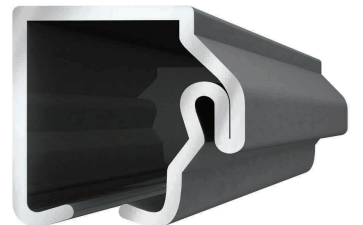

Çelik  
Perde Rayı



**YÜKSELSAN**  
ÇADIR - BRANDA - DORSE AKSESUARLARI

## Profiller ve Yağmur Lastikleri

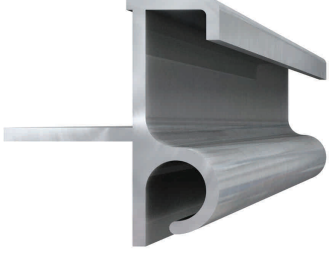

Yağmur  
Olucu



Germe Çıtası



34 mm  
Sarma Borusu



27 mm  
Sarma Borusu

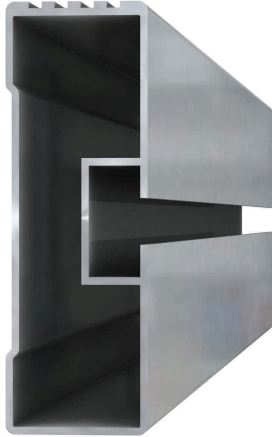

Bisikletlik

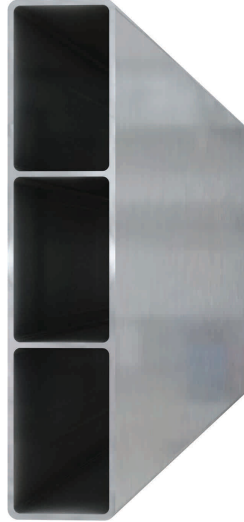

Tahtalık

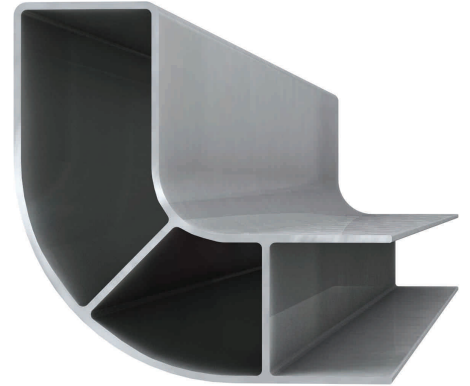

Oval Köşelik



Çelik Ray  
Yağmur Lastiği



Tepe Geçme  
Yağmur Lastiği

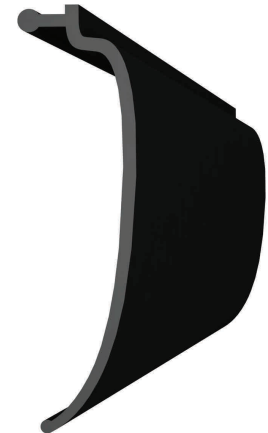

Yan Geçme  
Yağmur Lastiği



**YÜKSELSAN**  
ÇADIR - BRANDA - DORSE AKSESUARLARI

## Baba - Kayar Baba



Düz Baba  
Makarası



Z Tipi Baba  
Makarası

Kayar  
Baba

### Kayar Baba Makaraları



Çelik  
Gövdeli



Alüminyum  
Gövdeli

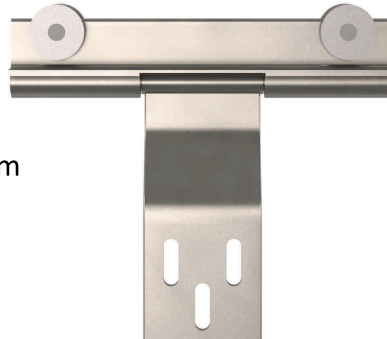
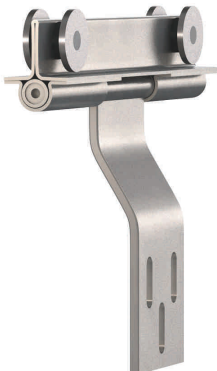

Kayar Baba



**YÜKSELSAN**  
ÇADIR - BRANDA - DORSE AKSESUARLARI

## Bariyerler, Bisikletlikler, Tahtalıklar



Bilyeli  
Yan Bariyer  
Ayağı



Kollu  
Yan Bariyer  
Ayağı

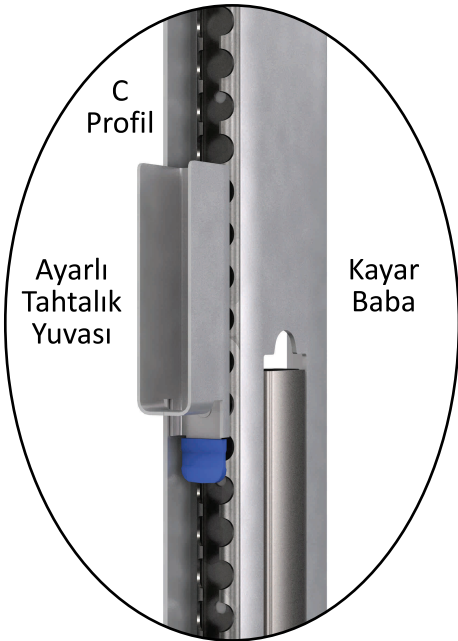

C  
Profil

Ayarlı  
Tahtalık  
Yuvası

Kayar  
Baba



Ayarlı  
Tahtalık Yuvası



C Profil



**YÜKSELSAN**  
ÇADIR - BRANDA - DORSE AKSESUARLARI

## Kilit Sistemleri



Arka Kapı Tutamağı

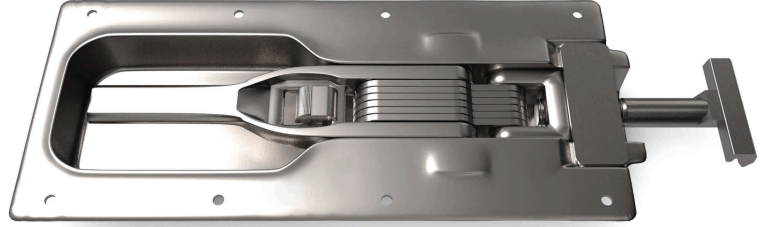

Gömme Dorse Kildi



Gizli Dilli Dikey Kilit  
(Alüminyum)



Dik Kilit  
Mekanizması



Alüminyum  
Profilli  
Dik Kilit



Sac Profilli  
Dik Kilit



**YÜKSELSAN**  
ÇADIR - BRANDA - DORSE AKSESUARLARI

## Katlanabilir Plastik Levhalar

500 mm.



**Pimli Tip**

600 mm.



450 mm.



500 mm.



**Tırnaklı Tip**

570 mm.



650 mm.



600 mm.

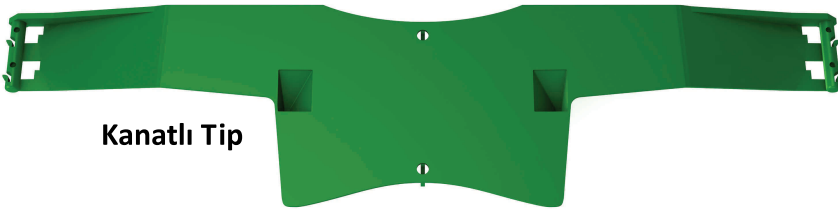

**Kanatlı Tip**

570 mm.



**Perçinli Tip**

650 mm.



**Bağlantı  
Plakası**



**YÜKSELSAN**  
ÇADIR - BRANDA - DORSE AKSESUARLARI

Branda, Tentelik, Mika

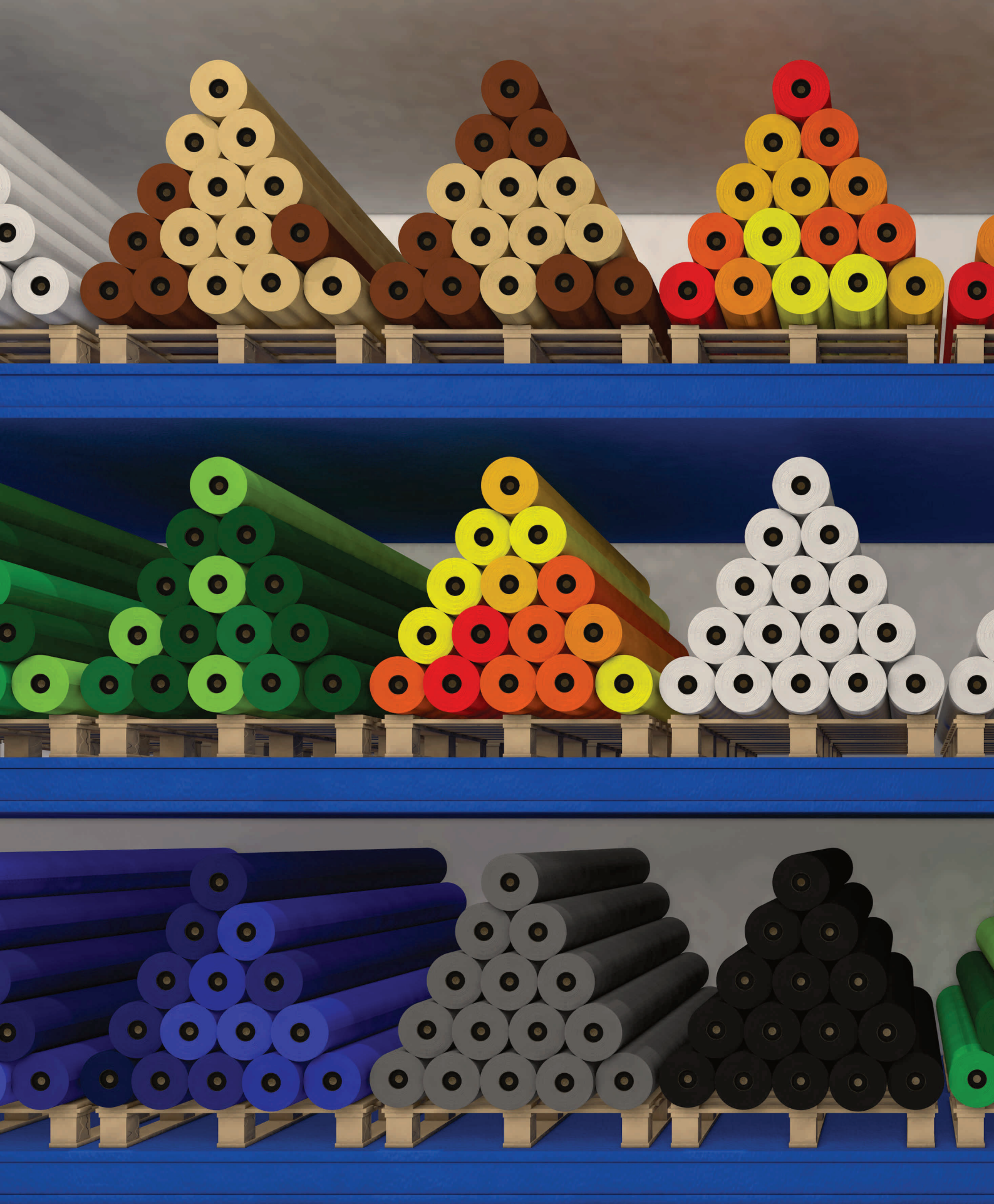



**YÜKSELSAN**  
ÇADIR - BRANDA - DORSE AKSESUARLARI

## Branda, Tentelik, Mika

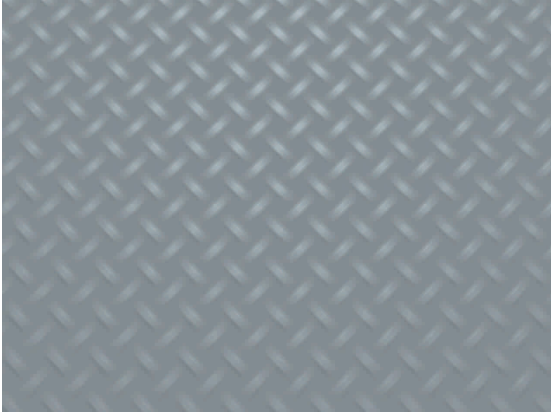

**Tentelik**  
450 Denye  
430 gr/m<sup>2</sup>  
140 cm. genişlik

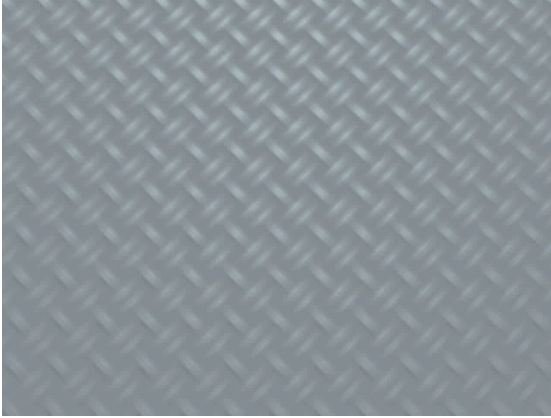

**İplik Dokuma**  
1100 Denye  
450 - 550 - 650 - 700 - 730 gr/m<sup>2</sup>  
150 ve 300 cm. genişlik

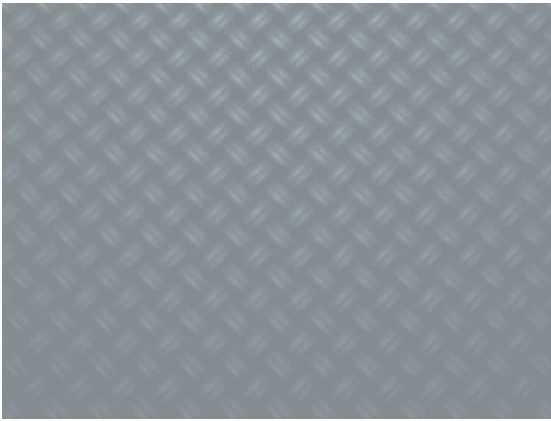

**Yarı Panama**  
700 gr/m<sup>2</sup>  
300 cm. genişlik



**Mika**  
0,6 - 0,8 - 1,0 mm  
135 ve 150 cm. genişlik



**YÜKSELSAN**  
ÇADIR - BRANDA - DORSE AKSESUARLARI

## Körüklü Tente

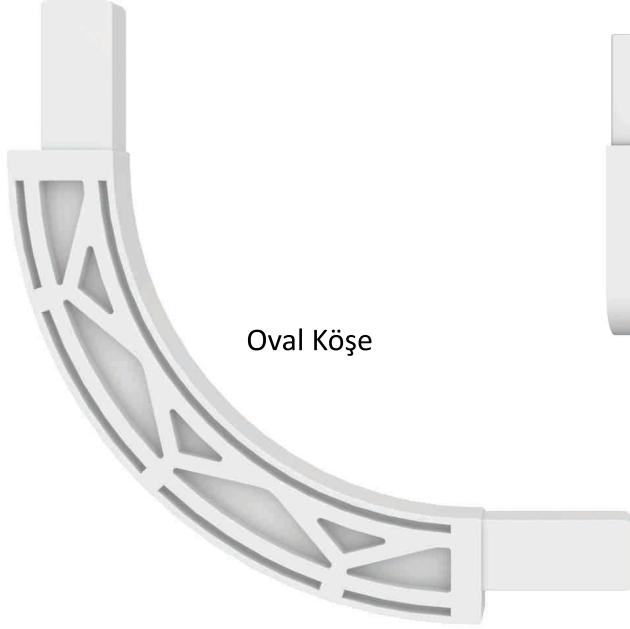

Oval Köşe



Ayak Takımı

15 x 25 mm



Arka Çerçeve Gönyesi



Ayak Takımı

20 x 20 mm

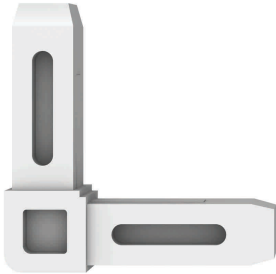

Arka Çerçeve Gönyesi

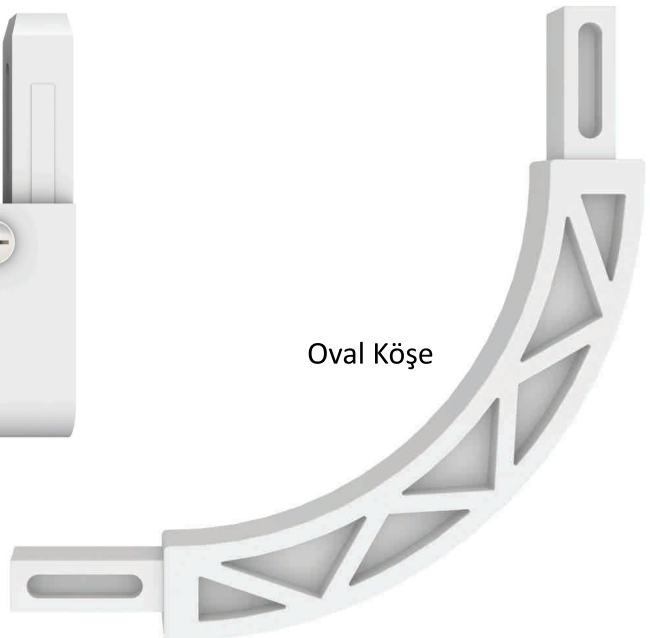

Oval Köşe



**YÜKSELSAN**  
ÇADIR - BRANDA - DORSE AKSESUARLARI

## Körüklü Tente

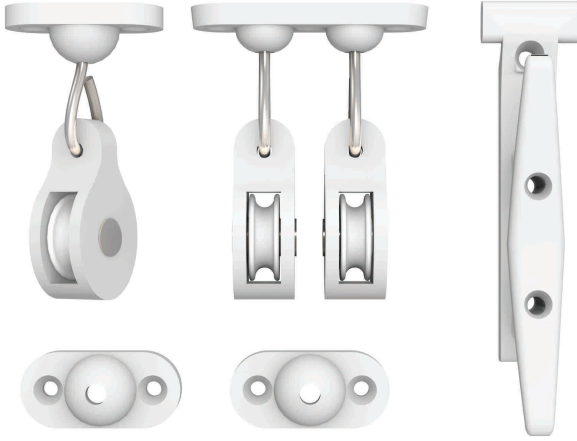

Makara Takımı



Kabara



Mafsallı Tente Bağlantı Ayağı

Körüklü Tente Şeridi ve İpi





**YÜKSELSAN**  
KAYAR ÇATI SİSTEMLERİ ve AKSESUARLARI

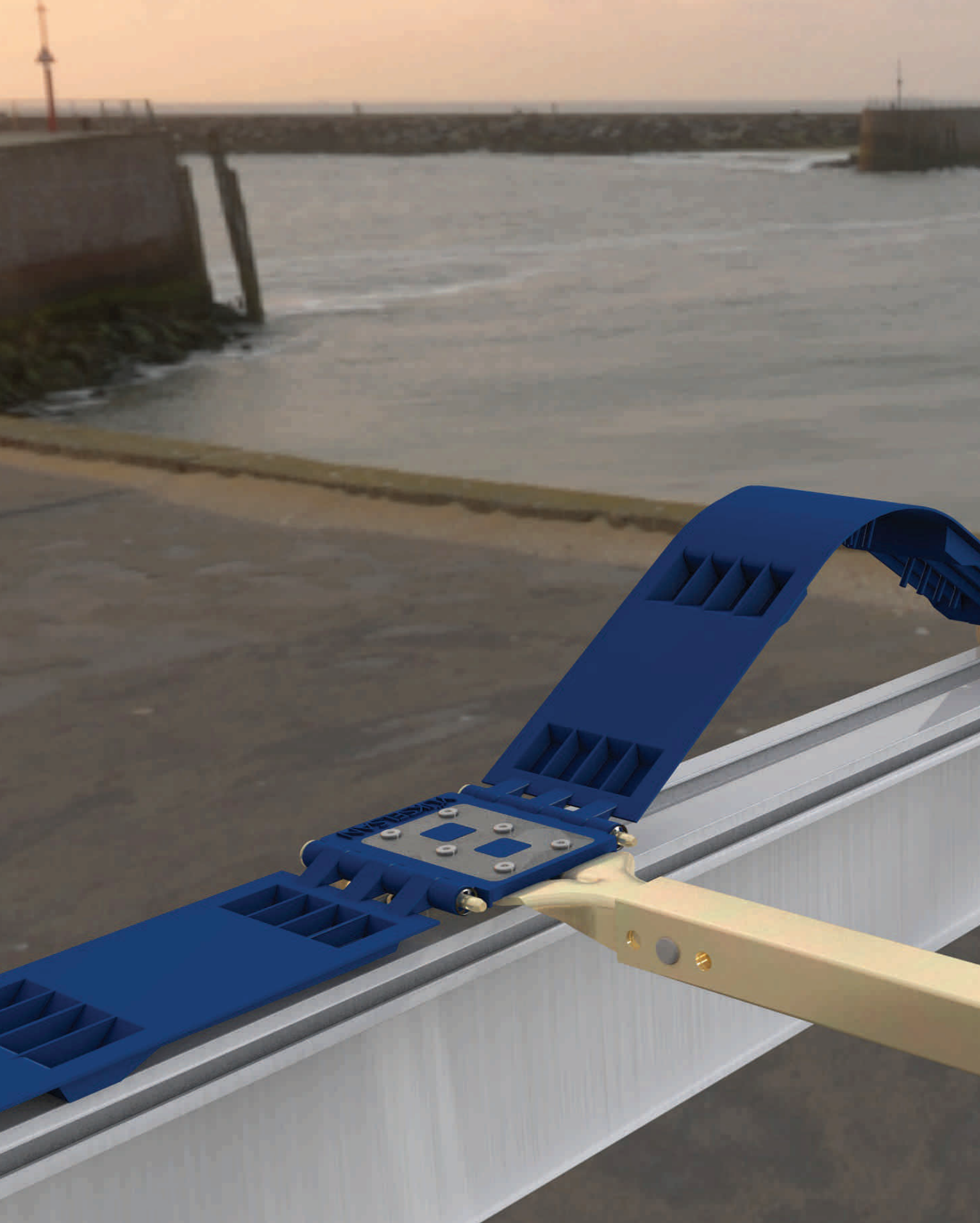



**YÜKSELSAN**  
ÇADIR - BRANDA - DORSE AKSESUARLARI

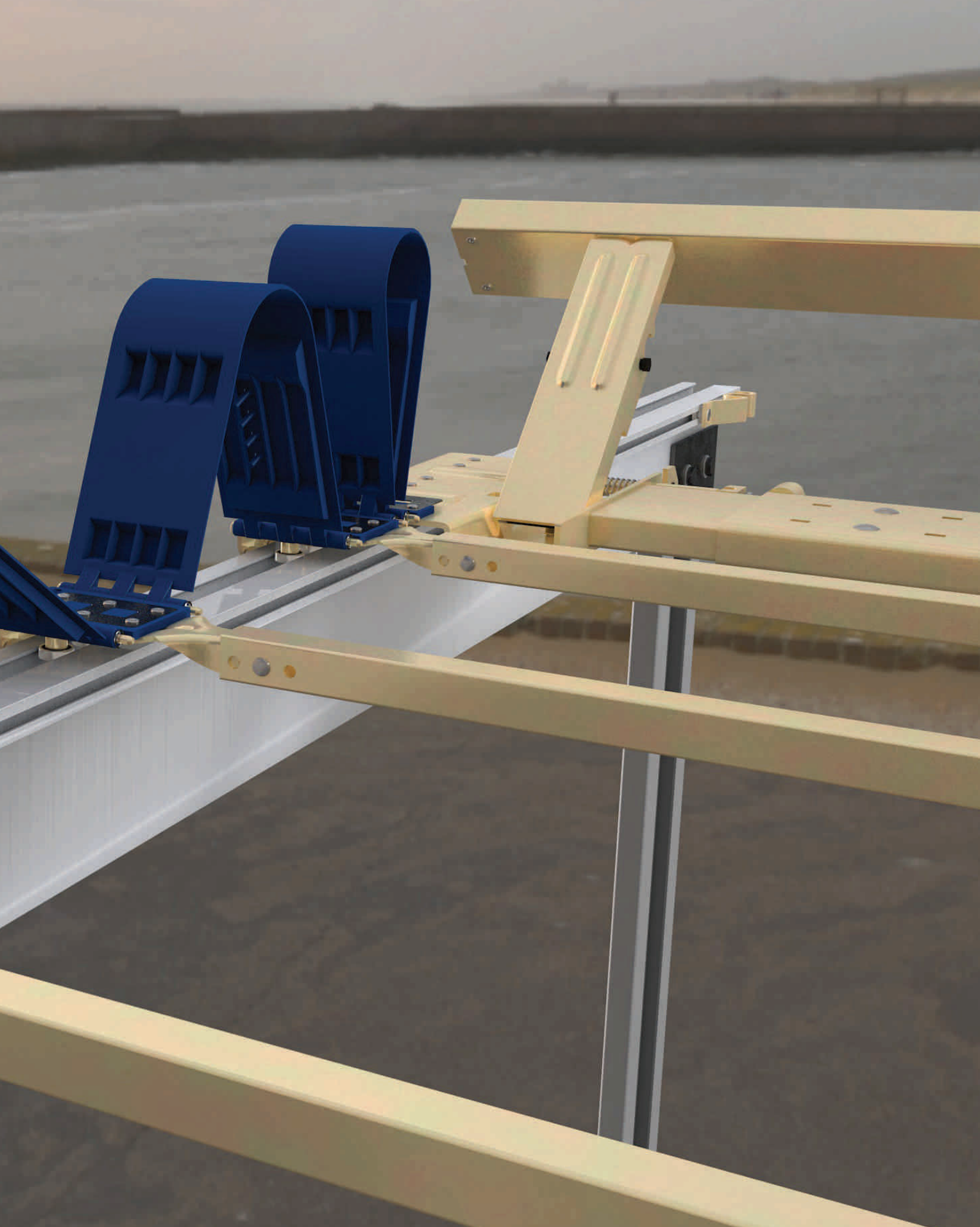



# YÜKSELSAN

**Yükselsan Treyler Ekipmanları San. Tic. Ltd. Şti.**

Maltepe Mah. Gümüşsuyu Cad. Çiftehavuzlar Yolu Mutlu Aksu Sanayi Sitesi No: 24, 34010 Zeytinburnu / İstanbul

**Telefon:** (0212) 482 40 19 - 29 (0212) 482 49 86 **Fax:** (0212) 481 49 02

**e-mail:** info@yukselsan.com - yukselsan@ttmail.com - nurbidzeynep@gmail.com **web:** www.yukselsan.com